

# GÜHRING

## CONVENTIONAL GUN DRILLS

Standard and special solutions from diameter 0.9 mm and up to a total length of 3000 mm

- | EB 100
- | EB 80
- | ZB 80
- | EB 800
- | Re-grinding
- | Accessories

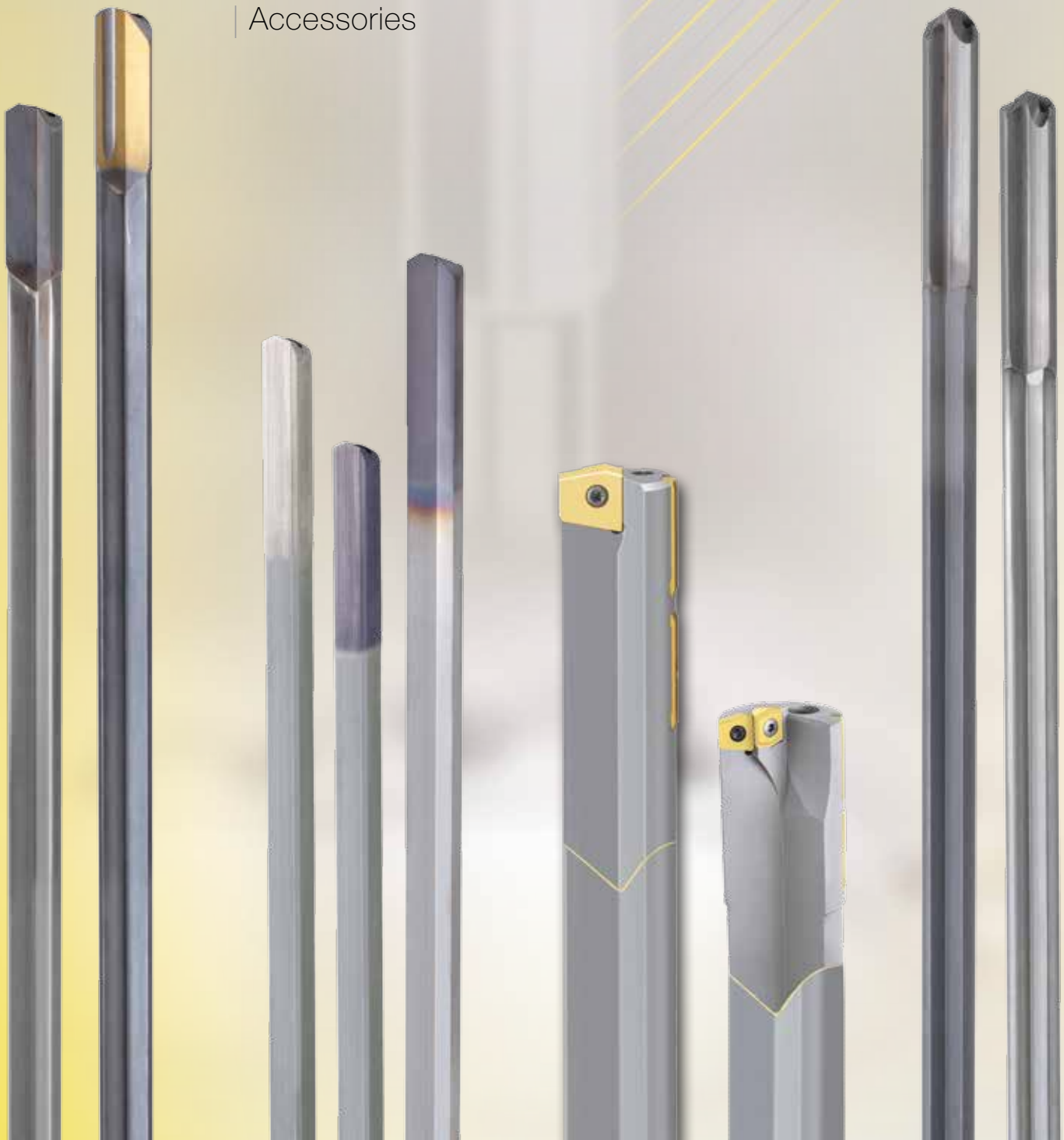

Solid carbide single-fluted gun drills EB 100



Single-fluted gun drills EB 80 with brazed carbide head



Two-fluted gun drills ZB 80 with brazed carbide head



Single-fluted gun drills EB 800 with interchangeable wear arts



Grinding equipment and accessories



Technical section

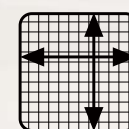

Enquiry form



**GÜHRING** NAVIGATOR



suitable for most materials	<ul style="list-style-type: none"> <li>• ex-stock range Ø 1.2 - 12.0 mm</li> <li>• special solutions Ø 0.9 - 16.0 mm</li> <li>• quick service</li> </ul>	<p><b>NEW:</b> EB 100 mono for 25/50/75 x D</p>	page 5
suitable for most materials	<ul style="list-style-type: none"> <li>• ex-stock range Ø 3.97 - 22.0 mm</li> <li>• special solutions Ø 2.0 - 40.0 mm</li> <li>• quick service Ø 2.0 - 22.0 mm and Inch sizes</li> </ul>	<p><b>NEW:</b> EB 80 XXL Ø 6.0 - 22.0 mm</p>	page 17
suitable for cast iron, aluminium and short-chipping non-ferrous metals	<ul style="list-style-type: none"> <li>• ex-stock range Ø 8.0 - 12.0 mm</li> <li>• special solutions Ø 6.0 - 30.0 mm</li> </ul>		page 27
suitable for most materials	<ul style="list-style-type: none"> <li>• ex-stock range Ø 12.0 - 24.0 mm</li> <li>• special solutions Ø 12.0 - 52.0 mm</li> </ul>		page 31
for re-grinding single-flute drills and for application on deep hole drilling machines	<ul style="list-style-type: none"> <li>• wide range of accessories for the application on deep hole drilling machines</li> </ul>		page 36
deep hole drilling from a - z	<ul style="list-style-type: none"> <li>• application on conventional machines</li> <li>• drilling application</li> <li>• hole accuracy</li> <li>• drivers for conventional gun drills</li> </ul>		page 45
for special solutions for your specific application task	<ul style="list-style-type: none"> <li>• EB 100</li> <li>• EB 80</li> <li>• ZB 80</li> <li>• EB 800</li> </ul>		page 49
application recommendations for all gun drills and materials	<ul style="list-style-type: none"> <li>• cooling lubricant data</li> <li>• cutting rate recommendations</li> </ul>		page 56

## Versatile

- for deep holes from  $\varnothing$  0.9 to 52.0 mm
- up to max. 3000 mm total length

EB 100 - the smallest



EB 80 - the conventional



ZB 80 - specialist for cast iron



EB 800 - the flexible

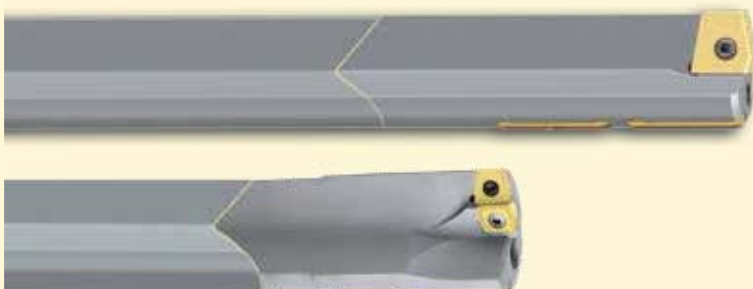

# EB 100

## THE SMALLEST

EB 100



- gun drills for extra tight drilling tolerances
- manufactured from 0.9 mm nominal diameter
- nominal diameter to 16.00 mm
- flute length to 500.00 mm
- up to 80xD with only one tool
- suitable for most materials



# Single-fluted gun drills EB 100

Standard	Type	Tool illustration	Flute length	Tool material	Surface finish	Diameter range	Guhring no.	Discount group	Standard range page
----------	------	-------------------	--------------	---------------	----------------	----------------	-------------	----------------	---------------------

Single-fluted gun drills EB 100, flute length dependent on drilling depth

Guhring std.	EB 100		25xD	Solid carbide		2.380 - 12.000	5646	123	8			
Guhring std.	EB 100		50xD			2.380 - 8.000				5647	123	9
Guhring std.	EB 100		75xD			2.380 - 6.000				5648	123	10



TiAlN nanoA-coated design for most materials



Solid carbide solid shank with conical MQL shank end\*

# Single-fluted gun drills EB 100

Standard	Type	Tool illustration	Flute length	Tool material	Surface finish	Diameter range	Gühring no.	Discount group	Standard range page
----------	------	-------------------	--------------	---------------	----------------	----------------	-------------	----------------	---------------------

## Single-fluted gun drills EB 100 with fixed flute lengths

Gühring std.	EB 100		45	Solid carbide	○	1.200 - 3.200	<b>5024</b>	123	11
Gühring std.	EB 100		45	Solid carbide	ⓐ	2.000 - 3.200	<b>5632</b>	123	11
Gühring std.	EB 100		80	Solid carbide	○	1.200 - 5.000	<b>5020</b>	123	12
Gühring std.	EB 100		80	Solid carbide	ⓐ	2.000 - 5.000	<b>5633</b>	123	12
Gühring std.	EB 100		120	Solid carbide	○	1.500 - 5.000	<b>5026</b>	123	13
Gühring std.	EB 100		120	Solid carbide	ⓐ	2.000 - 5.000	<b>5637</b>	123	13
Gühring std.	EB 100		160	Solid carbide	○	1.500 - 8.000	<b>5021</b>	123	14
Gühring std.	EB 100		160	Solid carbide	ⓐ	2.000 - 8.000	<b>5638</b>	123	14



TiAlN SuperA-coated design for alloyed and high-alloyed steels



Bright design for all other materials

# Single-fluted gun drills EB 100

<b>Guhring no.</b>	<b>5646</b>
<b>Standard</b>	<b>Guhring standard</b>
<b>Tool material</b>	<b>Solid carbide</b>
<b>Carbide grade</b>	<b>K30/K40</b>
<b>Surface finish</b>	<b>ⓐ</b>
<b>Drilling depth</b>	<b>25xD</b>
<b>Cutting direction</b>	<b>right-hand</b>
<b>Tolerance</b>	<b>h5</b>
<b>Discount group</b>	<b>123</b>

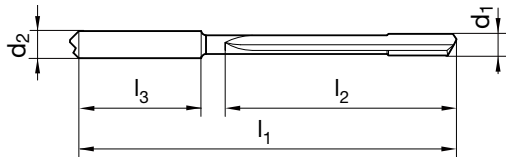

Code	d1	d2	l1	l2	l3	Availability
no.	mm	mm	mm	mm	mm	
2.380	2.380	4.000	100.00	70.00	28.00	●
2.500	2.500	4.000	115.00	85.00	28.00	●
2.780	2.780	4.000	115.00	85.00	28.00	●
3.000	3.000	6.000	145.00	105.00	36.00	●
3.170	3.170	6.000	145.00	105.00	36.00	●
3.500	3.500	6.000	145.00	105.00	36.00	●
3.970	3.970	6.000	160.00	120.00	36.00	●
4.000	4.000	6.000	160.00	120.00	36.00	●
5.000	5.000	6.000	220.00	180.00	36.00	●
5.560	5.560	6.000	220.00	180.00	36.00	●
6.000	6.000	6.000	220.00	180.00	36.00	●
6.350	6.350	8.000	260.00	210.00	36.00	●
7.000	7.000	8.000	260.00	210.00	36.00	●
7.140	7.140	8.000	285.00	240.00	36.00	●
8.000	8.000	8.000	285.00	240.00	36.00	●
9.000	9.000	10.000	350.00	300.00	40.00	●
10.000	10.000	10.000	350.00	300.00	40.00	●
11.000	11.000	12.000	420.00	360.00	45.00	●
12.000	12.000	12.000	420.00	360.00	45.00	●



# Single-fluted gun drills EB 100

<b>Guhring no.</b>	<b>5647</b>
<b>Standard</b>	<b>Guhring standard</b>
<b>Tool material</b>	<b>Solid carbide</b>
<b>Carbide grade</b>	<b>K30/K40</b>
<b>Surface finish</b>	<b>Ⓐ</b>
<b>Drilling depth</b>	<b>50xD</b>
<b>Cutting direction</b>	<b>right-hand</b>
<b>Tolerance</b>	<b>h5</b>
<b>Discount group</b>	<b>123</b>

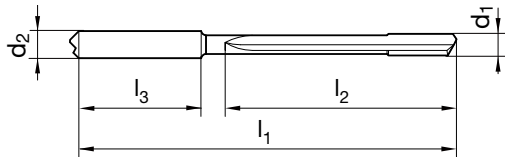

Code	d1	d2	l1	l2	l3
no.	mm	mm	mm	mm	mm
2.380	2.380	4.000	160.00	130.00	28.00
2.500	2.500	4.000	185.00	155.00	28.00
2.780	2.780	4.000	185.00	155.00	28.00
3.000	3.000	6.000	230.00	190.00	36.00
3.170	3.170	6.000	230.00	190.00	36.00
3.500	3.500	6.000	230.00	190.00	36.00
3.970	3.970	6.000	260.00	220.00	36.00
4.000	4.000	6.000	260.00	220.00	36.00
5.000	5.000	6.000	370.00	330.00	36.00
5.560	5.560	6.000	370.00	330.00	36.00
6.000	6.000	6.000	370.00	330.00	36.00
6.350	6.350	8.000	430.00	385.00	36.00
7.000	7.000	8.000	430.00	385.00	36.00
7.140	7.140	8.000	485.00	440.00	36.00
8.000	8.000	8.000	485.00	440.00	36.00

Availability
●
●
●
●
●
●
●
●
●
●
●
●
●
●
●
●
●
●
●
●
●
●

Ⓐ TiAlN nanoA

# Single-fluted gun drills EB 100

<b>Guhring no.</b>	<b>5648</b>
<b>Standard</b>	<b>Guhring standard</b>
<b>Tool material</b>	<b>Solid carbide</b>
<b>Carbide grade</b>	<b>K30/K40</b>
<b>Surface finish</b>	<b></b>
<b>Drilling depth</b>	<b>75xD</b>
<b>Cutting direction</b>	<b>right-hand</b>
<b>Tolerance</b>	<b>h5</b>
<b>Discount group</b>	<b>123</b>

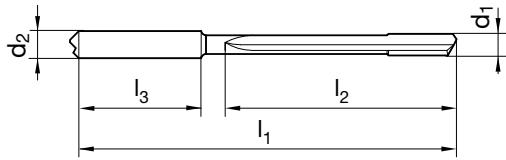

Code	d1	d2	l1	l2	l3
no.	mm	mm	mm	mm	mm
2.380	2.380	4.000	220.00	190.00	28.00
2.500	2.500	4.000	255.00	220.00	28.00
2.780	2.780	4.000	255.00	220.00	28.00
3.000	3.000	6.000	320.00	280.00	36.00
3.170	3.170	6.000	320.00	280.00	36.00
3.500	3.500	6.000	320.00	280.00	36.00
3.970	3.970	6.000	360.00	320.00	36.00
4.000	4.000	6.000	360.00	320.00	36.00
5.000	5.000	6.000	525.00	485.00	36.00
5.560	5.560	6.000	525.00	485.00	36.00
6.000	6.000	6.000	525.00	485.00	36.00

Availability	
	●
	●
	●
	●
	●
	●
	●
	●
	●
	●
	●
	●
	●
	●
	●
	●
	●
	●
	●
	●
	●
	●
	●
	●

# Single-fluted gun drills EB 100

<b>Guhring no.</b>	<b>5024</b>	<b>5632</b>
<b>Standard</b>	<b>Guhring standard</b>	<b>Guhring standard</b>
<b>Tool material</b>	<b>Solid carbide</b>	<b>Solid carbide</b>
<b>Carbide grade</b>	<b>K30/K40</b>	<b>K30/K40</b>
<b>Surface finish</b>	○	<b>A</b>
<b>Flute length (mm)</b>	<b>45.00</b>	<b>45.00</b>
<b>Cutting direction</b>	<b>right-hand</b>	<b>right-hand</b>
<b>Tolerance</b>	<b>h5</b>	<b>h5</b>
<b>Discount group</b>	<b>123</b>	<b>123</b>

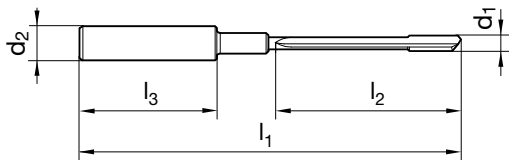

<b>Code</b>	<b>d1</b>	<b>d2</b>	<b>l1</b>	<b>l2</b>	<b>l3</b>
<b>no.</b>	<b>mm</b>	<b>mm</b>	<b>mm</b>	<b>mm</b>	<b>mm</b>
1,200	1.200	4.000	90.00	45.00	28.00
1,500	1.500	4.000	90.00	45.00	28.00
1,600	1.600	4.000	90.00	45.00	28.00
2,000	2.000	4.000	90.00	45.00	28.00
2,500	2.500	10.000	100.00	45.00	40.00
2,700	2.700	10.000	100.00	45.00	40.00
3,000	3.000	10.000	100.00	45.00	40.00
3,200	3.200	10.000	100.00	45.00	40.00

<b>Availability</b>	
---------------------	--

●	
●	
●	
●	●
●	●
●	●
●	●
●	●

○ bright

**A** TiAIN SuperA

# Single-fluted gun drills EB 100

<b>Guhring no.</b>	<b>5020</b>	<b>5633</b>
<b>Standard</b>	<b>Guhring standard</b>	<b>Guhring standard</b>
<b>Tool material</b>	<b>Solid carbide</b>	<b>Solid carbide</b>
<b>Carbide grade</b>	<b>K30/K40</b>	<b>K30/K40</b>
<b>Surface finish</b>	○	Ⓜ
<b>Flute length (mm)</b>	<b>80.00</b>	<b>80.00</b>
<b>Cutting direction</b>	<b>right-hand</b>	<b>right-hand</b>
<b>Tolerance</b>	<b>h5</b>	<b>h5</b>
<b>Discount group</b>	<b>123</b>	<b>123</b>

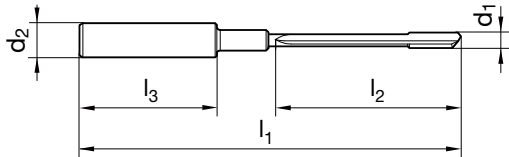

Code	d1	d2	l1	l2	l3
no.	mm	mm	mm	mm	mm
1,200	1.200	4.000	125.00	80.00	28.00
1,500	1.500	4.000	125.00	80.00	28.00
1,600	1.600	4.000	125.00	80.00	28.00
2,000	2.000	4.000	125.00	80.00	28.00
2,500	2.500	10.000	135.00	80.00	40.00
2,700	2.700	10.000	135.00	80.00	40.00
3,000	3.000	10.000	135.00	80.00	40.00
3,200	3.200	10.000	135.00	80.00	40.00
3,500	3.500	10.000	135.00	80.00	40.00
4,000	4.000	10.000	135.00	80.00	40.00
4,200	4.200	10.000	135.00	80.00	40.00
4,500	4.500	10.000	135.00	80.00	40.00
5,000	5.000	10.000	135.00	80.00	40.00

Availability	
●	
●	
●	
●	●
●	●
●	●
●	●
●	●
●	●
●	●
●	●
●	●

○ bright

Ⓜ TiAlN SuperA

# Single-fluted gun drills EB 100

Guhring no.	5026	5637
Standard	Guhring standard	Guhring standard
Tool material	Solid carbide	Solid carbide
Carbide grade	K30/K40	K30/K40
Surface finish	○	<span style="color: red;">A</span>
Flute length (mm)	120.00	120.00
Cutting direction	right-hand	right-hand
Tolerance	h5	h5
Discount group	123	123

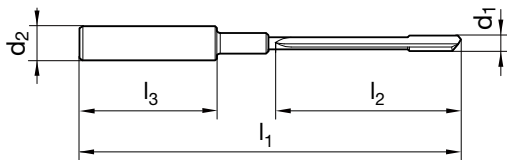

Code	d1	d2	l1	l2	l3	Availability
no.	mm	mm	mm	mm	mm	
1,500	1.500	4.000	165.00	120.00	28.00	●
1,600	1.600	4.000	165.00	120.00	28.00	●
2,000	2.000	4.000	165.00	120.00	28.00	●
2,500	2.500	10.000	175.00	120.00	40.00	● ●
2,700	2.700	10.000	175.00	120.00	40.00	● ●
3,000	3.000	10.000	175.00	120.00	40.00	● ●
3,200	3.200	10.000	175.00	120.00	40.00	● ●
3,500	3.500	10.000	175.00	120.00	40.00	● ●
4,000	4.000	10.000	175.00	120.00	40.00	● ●
4,200	4.200	10.000	175.00	120.00	40.00	● ●
4,500	4.500	10.000	175.00	120.00	40.00	● ●
5,000	5.000	10.000	175.00	120.00	40.00	● ●

# Single-fluted gun drills EB 100

Guhring no.	5021	5638
Standard	Guhring standard	Guhring standard
Tool material	Solid carbide	Solid carbide
Carbide grade	K30/K40	K30/K40
Surface finish	○	Ⓐ
Flute length (mm)	160.00	160.00
Cutting direction	right-hand	right-hand
Tolerance	h5	h5
Discount group	123	123

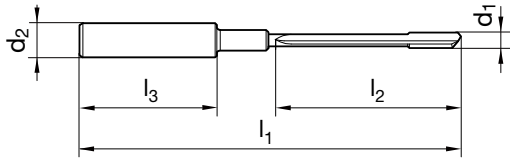

Code	d1	d2	l1	l2	l3
no.	mm	mm	mm	mm	mm
1,500	1.500	4.000	205.00	160.00	28.00
1,600	1.600	4.000	205.00	160.00	28.00
2,000	2.000	4.000	205.00	160.00	28.00
2,500	2.500	10.000	215.00	160.00	40.00
2,700	2.700	10.000	215.00	160.00	40.00
3,000	3.000	10.000	215.00	160.00	40.00
3,200	3.200	10.000	215.00	160.00	40.00
3,500	3.500	10.000	215.00	160.00	40.00
4,000	4.000	10.000	215.00	160.00	40.00
4,200	4.200	10.000	215.00	160.00	40.00
4,500	4.500	10.000	215.00	160.00	40.00
5,000	5.000	10.000	215.00	160.00	40.00
6,000	6.000	16.000	225.00	160.00	48.00
8,000	8.000	16.000	225.00	160.00	48.00

Availability	
●	
●	
●	●
●	●
●	●
●	●
●	●
●	●
●	●
●	●
●	●
●	●
●	●
●	●
●	●
●	●
●	●
●	●
●	●

○ bright      Ⓐ TiAlN SuperA

# Single-fluted gun drills EB 100

## Suitable for most materials

ex-stock range from  $\varnothing$  1.2 to 12.0 mm

special solutions from  $\varnothing$  0.9 to 16.0 mm, max. flute length 500 mm

enquiry form see page 50 and 51 (quick service see page 16)



For certain materials a coating is required, as the successful application of gun drills with a bright surface finish cannot be guaranteed. For coating definitions see GuhringNavigator.

- S TiN-coated
- F FIRE
- A TiAlN SuperA
- a TiAlN nanoA

### The dimensions required to calculate the length for conventional machine tools

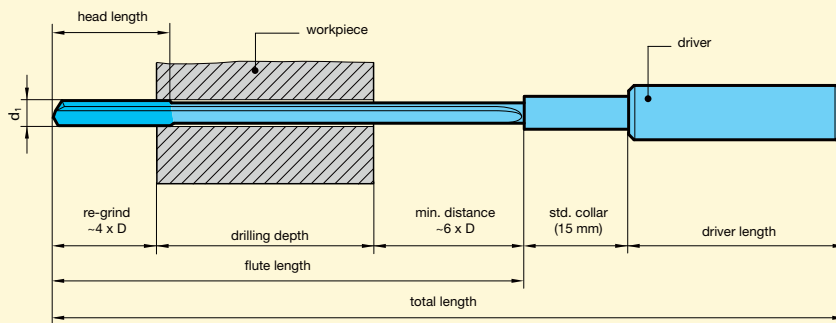

### EB 100

#### Head forms

(Position of guide pads. Special head forms on request.)



suitable for all materials, but for smaller hole tolerances

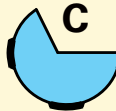

suitable for difficult-to-machine materials, i. e. high-alloyed steel

### EB 100 Standard point grinds

(special point grinds on request)

$\varnothing$  0.9...4.00 mm

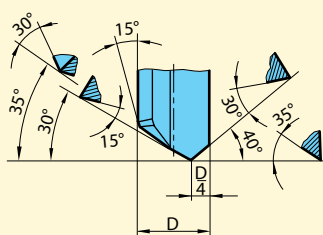

$\varnothing$  > 4.01...20 mm

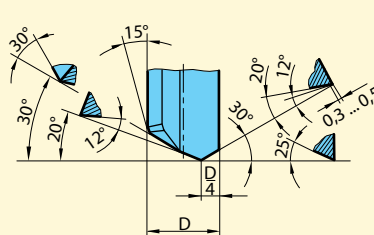

### EB 100

#### Back taper ratio

(dimensions in mm)

1:800 (standard)

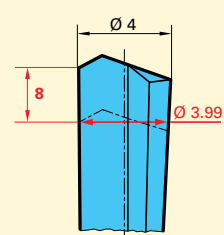

## Super fast gun drill delivery

Your tailor-made single-fluted EB 100 gun drills with brazed shank!  
Gühring's super quick gun drill offer makes it possible:  
Special tools within 15 working days!



Design options:

- flute length:

45 mm  $\varnothing$  1.2 / 1.5 / 1.6 / 2.0 / 2.5 / 2.7 / 3.0 / 3.2

80 mm  $\varnothing$  1.5 / 1.6 / 2.0 / 2.5 / 2.7 / 3.0 / 3.2 / 3.5 / 4.0 / 4.2 / 4.5 / 5.0

120 mm  $\varnothing$  1.5 / 1.6 / 2.0 / 2.5 / 2.7 / 3.0 / 3.2 / 3.5 / 4.0 / 4.2 / 4.5 / 5.0

160 mm  $\varnothing$  1.5 / 1.6 / 2.0 / 2.5 / 2.7 / 3.0 / 3.2 / 3.5 / 4.0 / 4.2 / 4.5 / 5.0 / 6.0 / 8.0

- carbide grade: K30/K40
- head form: G
- bright finish or coated
- in combination with standard driver

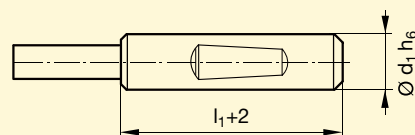
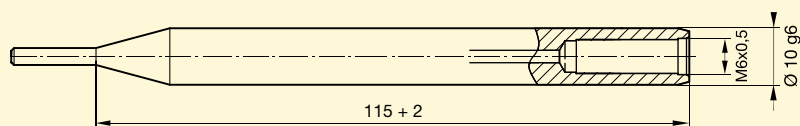

enquiry form see page 51

## PCD corner tipped

Every solid carbide single-flute gun drill is available tipped with PCD,  
nominal diameter range 6.00 – 16.00 mm.

Your advantages of PCD corner tipping:

- up to 10 times longer tool life in aluminum
- minimal machine downtime
- no built-up edge in aluminum

Please talk to us!





# EB 80

## THE CONVENTIONAL

EB 80









- single-fluted gun drills with brazed carbide head
- total length to 3000.00 mm
- nominal diameter from 2.00 to 40.00 mm
- wide range of options, i.e. ball nosed or step drill
- suitable for most materials



# Single-fluted gun drills EB 80

Standard	Type	Tool illustration	Drilling depth	Tool material	Surface finish	Diameter range	Guhring no.	Discount group	Standard range page
----------	------	-------------------	----------------	---------------	----------------	----------------	-------------	----------------	---------------------

## Single-fluted gun drills EB 80

Guhring std.	EB 80		20 x D	Carbide	S	4.000 - 12.000	5018	123	19
Guhring std.	EB 80		20 x D	Carbide	C	3.970 - 12.700	5639	123	19
Guhring std.	EB 80		30 x D	Carbide	S	4.000 - 12.000	5460	123	20
Guhring std.	EB 80		30 x D	Carbide	C	3.970 - 12.700	5640	123	20
Guhring std.	EB 80		40 x D	Carbide	S	4.000 - 12.000	5022	123	21
Guhring std.	EB 80		40 x D	Carbide	C	3.970 - 12.700	5641	123	21
Guhring std.	EB 80		80 x D	Carbide	S	4.950 - 11.950	5023	123	22
Guhring std.	EB 80		80 x D	Carbide	C	3.970 - 12.700	5642	123	22
Guhring std.	EB 80		1100 mm	Carbide	S	6.000 - 22.000	5164	123	25



TiN-coated design with chip breaker for long-chipping steels



TiCN-coated design without chip breaker for alloyed and high-alloyed steels

## Fast service for brazed single-fluted gun drills (see page 53)

In addition to the ex-stock range, Guhring offers quick availability or delivery for the following dimensions. Delivery time maximum 3 weeks. Please complete the form on page 53 for your enquiry/order.

Ø nominal mm	in increments of mm	head form	total length	prices on request
2.00...13.90	0.1	G	≤ 7.5 mm Ø 650 max	
4.00...13.90	0.1	C	> 7.5 mm Ø 1200 max	
14.00...22.00	0.5	G	1200 max	
14.00...22.00	0.5	C	1200 max	

Tool material:	solid carbide/K15
Surface:	○ / S / C
Standard head lengths (mm)	

nom. Ø	length	nom. Ø	length
2.00...2.49	15	10.00...10.99	35
2.50...2.99	18	11.00...17.00	40
3.00...3.99	20	17.01...20.00	45
4.00...5.19	25	20.01...23.00	50
5.20...6.99	30	23.01...26.00	55
7.00...9.99	35	26.01...40.00	65

Flute length: min. 20 x D

In addition to metric dimensions, fractional dimensions are also available as part of our quick availability. Please contact us!

S TiN

C TiCN

# Single-fluted gun drills EB 80

<b>Guhring no.</b>	<b>5018</b>	<b>5639</b>
<b>Standard</b>	<b>Guhring standard</b>	
<b>Tool material</b>	<b>Carbide</b>	
<b>Carbide grade</b>	<b>K15</b>	<b>K30/K40</b>
<b>Surface finish</b>	<b>(S)</b>	<b>(C)</b>
<b>Drilling depth</b>	<b>20 x D</b>	<b>20 x D</b>
<b>Cutting direction</b>	<b>right-hand</b>	<b>right-hand</b>
<b>Tolerance</b>	<b>h5</b>	<b>h5</b>
<b>Discount group</b>	<b>123</b>	<b>123</b>

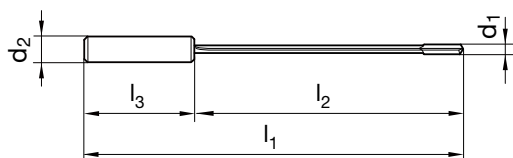

<b>Code</b>	<b>d1</b>	<b>d1</b>	<b>d2</b>	<b>l1</b>	<b>l2</b>	<b>l3</b>
<b>no.</b>	<b>inch</b>	<b>mm</b>	<b>mm</b>	<b>mm</b>	<b>mm</b>	<b>mm</b>
3,970	5/32	3.970	10.000	150.00	100.00	40.00
4,000		4.000	12.000	150.00	100.00	40.00
4,200		4.200	12.000	160.00	110.00	40.00
4,500		4.500	12.000	170.00	120.00	40.00
5,000		5.000	16.000	180.00	130.00	48.00
5,156	13/64	5.156	16.000	180.00	130.00	48.00
5,500		5.500	16.000	190.00	140.00	48.00
6,000		6.000	16.000	210.00	160.00	48.00
6,350	1/4	6.350	16.000	220.00	170.00	48.00
6,500		6.500	16.000	220.00	170.00	48.00
7,000		7.000	16.000	235.00	185.00	48.00
7,938	15/16	7.938	16.000	260.00	210.00	48.00
8,000		8.000	16.000	260.00	210.00	48.00
9,000		9.000	16.000	280.00	230.00	48.00
9,525	3/8	9.525	16.000	290.00	240.00	48.00
10,000		10.000	20.000	320.00	260.00	50.00
11,000		11.000	20.000	340.00	290.00	50.00
11,113	7/16	11.113	20.000	340.00	290.00	50.00
12,000		12.000	20.000	370.00	310.00	50.00
12,700	1/2	12.700	20.000	385.00	330.00	50.00

<b>Availability</b>	
●	●
●	●
●	●
●	●
●	●
●	●
●	●
●	●
●	●
●	●
●	●
●	●
●	●
●	●
●	●
●	●
●	●
●	●
●	●
●	●

# Single-fluted gun drills EB 80

Guhring no.	5460	5640
Standard	Guhring standard	
Tool material	Carbide	
Carbide grade	K15	K30/K40
Surface finish	Ⓢ	ⓐ
Drilling depth	30 x D	30 x D
Cutting direction	right-hand	right-hand
Tolerance	h5	h5
Discount group	123	123

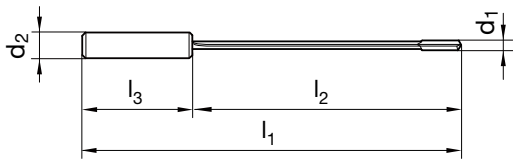

Code	d1	d1	d2	l1	l2	l3
no.	inch	mm	mm	mm	mm	mm
3,970	5/32	3.970	10.000	200.00	155.00	40.00
4,000		4.000	12.000	200.00	155.00	40.00
4,200		4.200	12.000	210.00	165.00	40.00
4,500		4.500	12.000	220.00	175.00	40.00
5,000		5.000	16.000	230.00	182.00	48.00
5,156	13/64	5.156	16.000	230.00	182.00	48.00
5,500		5.500	16.000	245.00	197.00	48.00
6,000		6.000	16.000	260.00	212.00	48.00
6,350	1/4	6.350	16.000	275.00	227.00	48.00
6,500		6.500	16.000	275.00	227.00	48.00
7,000		7.000	16.000	290.00	242.00	48.00
7,938	15/16	7.938	16.000	320.00	272.00	48.00
8,000		8.000	16.000	320.00	272.00	48.00
9,000		9.000	16.000	350.00	302.00	48.00
9,525	3/8	9.525	16.000	380.00	330.00	48.00
10,000		10.000	20.000	400.00	350.00	50.00
11,000		11.000	20.000	430.00	380.00	50.00
11,113	7/16	11.113	20.000	430.00	380.00	50.00
12,000		12.000	20.000	450.00	400.00	50.00
12,700	1/2	12.700	20.000	500.00	450.00	50.00

Availability	
	●
●	●
●	
●	●
●	●
●	●
●	●
●	●
●	●
●	●
●	●
●	●
●	●
●	●
	●
	●
	●
	●
	●
	●
	●
	●
	●
	●

# Single-fluted gun drills EB 80

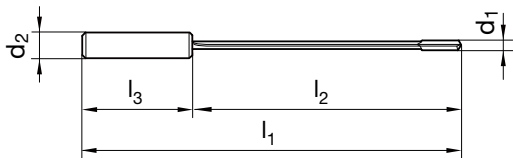

<b>Guhring no.</b>	<b>5022</b>	<b>5641</b>
<b>Standard</b>	<b>Guhring standard</b>	
<b>Tool material</b>	<b>Carbide</b>	
<b>Carbide grade</b>	<b>K15</b>	<b>K30/K40</b>
<b>Surface finish</b>	<b>(S)</b>	<b>(C)</b>
<b>Drilling depth</b>	<b>40 x D</b>	<b>40 x D</b>
<b>Cutting direction</b>	<b>right-hand</b>	<b>right-hand</b>
<b>Tolerance</b>	<b>h5</b>	<b>h5</b>
<b>Discount group</b>	<b>123</b>	<b>123</b>



<b>Code</b>	<b>d1</b>	<b>d1</b>	<b>d2</b>	<b>l1</b>	<b>l2</b>	<b>l3</b>
<b>no.</b>	<b>inch</b>	<b>mm</b>	<b>mm</b>	<b>mm</b>	<b>mm</b>	<b>mm</b>
3,970	5/32	3.970	10.000	230.00	185.00	40.00
4,000		4.000	12.000	230.00	185.00	40.00
4,200		4.200	12.000	240.00	195.00	40.00
4,500		4.500	12.000	250.00	205.00	40.00
5,000		5.000	16.000	280.00	232.00	48.00
5,156	13/64	5.156	16.000	280.00	232.00	48.00
5,500		5.500	16.000	300.00	252.00	48.00
6,000		6.000	16.000	320.00	272.00	48.00
6,350	1/4	6.350	16.000	340.00	292.00	48.00
6,500		6.500	16.000	340.00	292.00	48.00
7,000		7.000	16.000	370.00	322.00	48.00
7,938	15/16	7.938	16.000	430.00	372.00	48.00
8,000		8.000	16.000	430.00	372.00	48.00
9,000		9.000	16.000	450.00	402.00	48.00
9,525	3/8	9.525	16.000	480.00	432.00	48.00
10,000		10.000	20.000	510.00	460.00	50.00
11,000		11.000	20.000	550.00	500.00	50.00
11,113	7/16	11.113	20.000	550.00	500.00	50.00
12,000		12.000	20.000	600.00	550.00	50.00
12,700	1/2	12.700	20.000	635.00	585.00	50.00

<b>Availability</b>	
●	●
●	●
●	●
●	●
●	●
●	●
●	●
●	●
●	●
●	●
●	●
●	●
●	●
●	●
●	●
●	●
●	●
●	●
●	●
●	●
●	●
●	●

# Single-fluted gun drills EB 80

Guhring no.	5023	5642
Standard	Guhring standard	
Tool material	Carbide	
Carbide grade	K15	K30/K40
Surface finish		
Drilling depth	80 x D	80 x D
Cutting direction	right-hand	right-hand
Tolerance	h5	h5
Discount group	123	123

max. flute length per tool 40 x D, for larger drilling depths apply Guhring no. 5022 or 5641 as first tool.

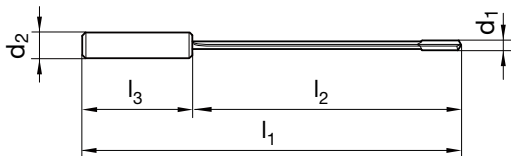

Code	d1	d1	d2	l1	l2	l3
no.	inch	mm	mm	mm	mm	mm
4.950		4.950	16.000	480.00	432.00	48.00
5.106		5.106	16.000	480.00	432.00	48.00
5.950	15/64	5.950	16.000	560.00	512.00	48.00
6.300		6.300	16.000	590.00	542.00	48.00
6.950		6.950	16.000	650.00	602.00	48.00
7.888		7.888	16.000	740.00	692.00	48.00
7.950		7.950	16.000	740.00	692.00	48.00
8.950		8.950	16.000	820.00	772.00	48.00
9.475		9.475	16.000	870.00	822.00	48.00
9.950		9.950	20.000	910.00	860.00	50.00
10.950		10.950	20.000	995.00	945.00	50.00
11.063		11.063	20.000	995.00	945.00	50.00
11.950		11.950	20.000	1080.00	1030.00	50.00
12.650		12.650	20.000	1140.00	1090.00	50.00

Availability	
●	●
	●
●	●
	●
	●
	●
●	●
	●
	●
	●
●	●
	●
	●
	●
	●
	●

# Single-fluted gun drills EB 80

## Suitable for most materials

ex-stock range from  $\varnothing$  3.97 to 22.0 mm

special solutions from  $\varnothing$  2.0 to 40.0 mm, max. total length 3000 mm

enquiry form see page 52 and 53 (for fast service see page 26)



For certain materials a coating is required, as the successful application of gun drills with a bright surface finish cannot be guaranteed. For coating definitions see GühringNavigator. On request we can apply PCD or PCB cutting edges from  $\varnothing$  6.0 – 20.00 mm. This improves the tool life in AISi alloys many times over.

- S TiN-coated
- F FIRE
- C TiCN
- Y Signum

### The dimensions required to calculate the length for conventional machine tools

\* max. flute length per tool  
 $40 \times D$ , for larger drilling depths apply two tools.  
 (i.e.  $\varnothing$  10 x 450 and  $\varnothing$  9.95 x 850 mm)

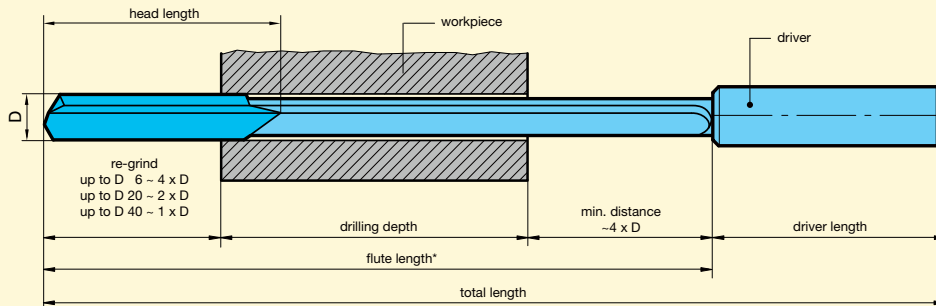

### EB 80 Head forms (position of guide pads)

Standard designs

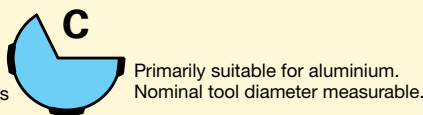
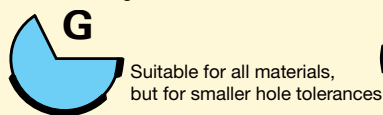

Special designs e.g.



### EB 80 standard point grinds without chip breaker groove (special point grinds available)

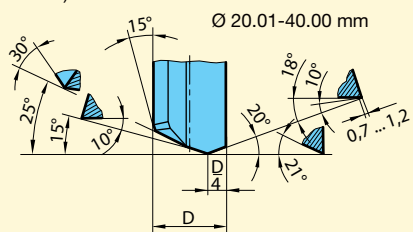
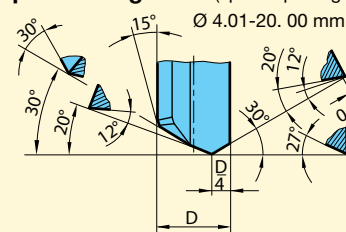
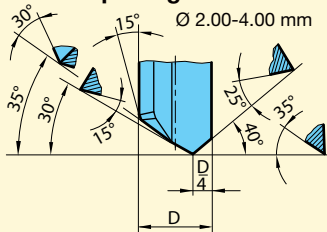

### EB 80 special point grind with chip breaker groove (standard Gühring no. 5018, 5460, 5022 and 5023)

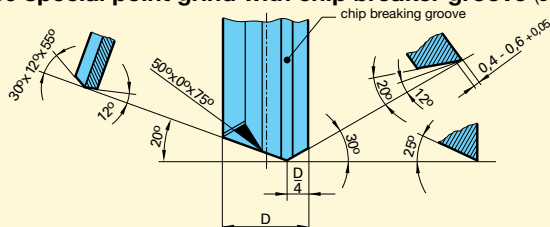

Standard head lengths (mm)			
$\varnothing$ -range	length	$\varnothing$ -range	length
2.00...2.49	15	10.00...10.99	35
2.50...2.99	18	11.00...17.00	40
3.00...3.99	20	17.01...20.00	45
4.00...5.19	25	20.01...23.00	50
5.20...6.99	30	23.01...26.00	55
7.00...9.99	35	26.01...40.00	65

### Special point grind examples for single-fluted EB 80 (additional point grinds on request)

with integral coolant chamber

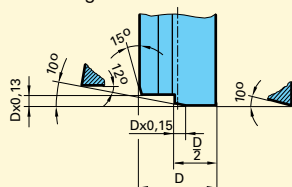

with chip breaking groove

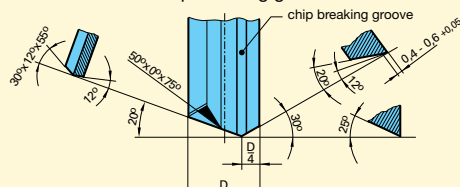

chip breaking groove with chip guiding step

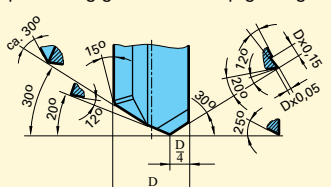

**Now available for deep hole drilling machines from stock**

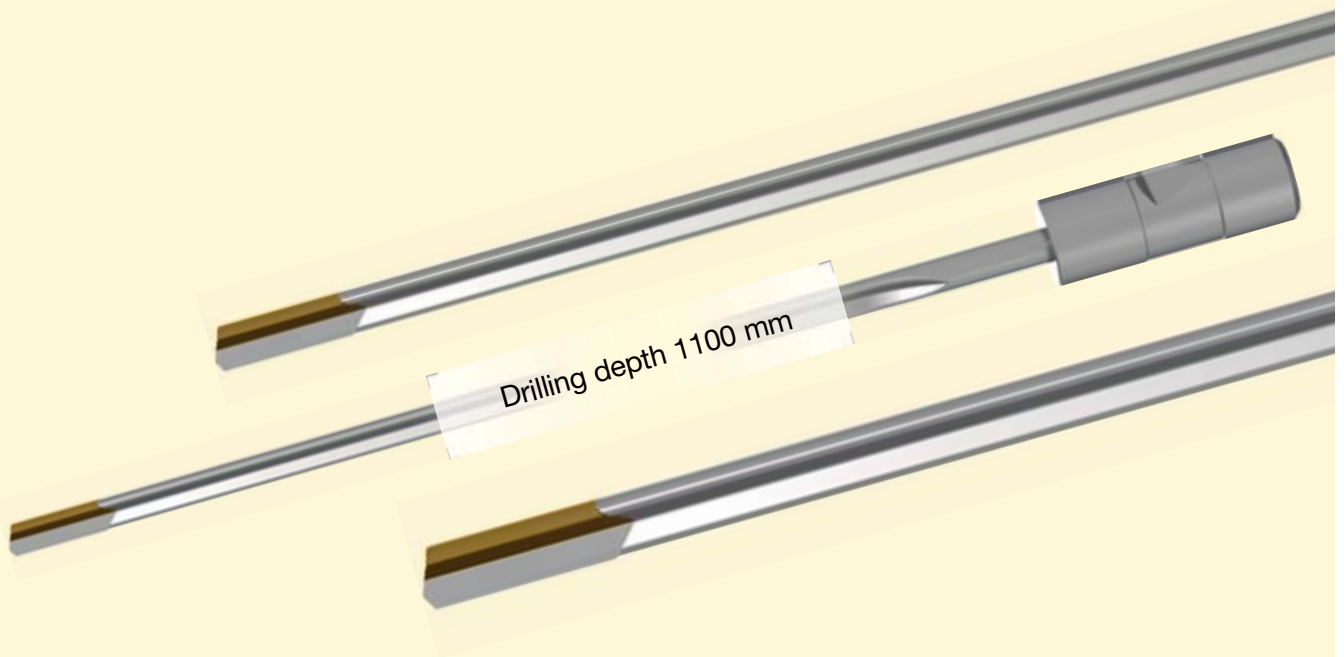

- available from stock within 24 hours
- overall length 1100 mm for all standard deep hole drilling machines
- driver D25x70mm for all standard deep hole drilling machines
- carbide grade K15 (DK105) suitable for best tool life in most materials
- head form G for highest precision
- TiN-coated for good tool life and difficult materials
- polished flute for optimum chip evacuation



# Single-fluted gun drills EB 80

<b>Guhring no.</b>	<b>5164</b>
<b>Standard</b>	<b>Guhring standard</b>
<b>Tool material</b>	<b>Carbide</b>
<b>Carbide grade</b>	<b>K15</b>
<b>Surface finish</b>	<b>S</b>
<b>Drilling depth</b>	<b>1100 mm</b>
<b>Cutting direction</b>	<b>right-hand</b>
<b>Tolerance</b>	<b>h5</b>
<b>Discount group</b>	<b>123</b>

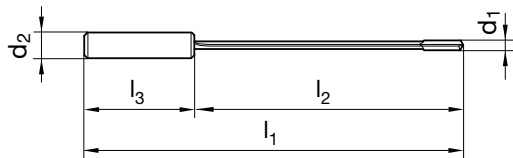

Code	d1	d1	d2	l1	l2	l3
no.	inch	mm	mm	mm	mm	mm
6.000		6.000	25.000	1100.00	1010.00	70.00
7.000		7.000	25.000	1100.00	1010.00	70.00
8.000		8.000	25.000	1100.00	1010.00	70.00
10.000		10.000	25.000	1100.00	1010.00	70.00
12.000		12.000	25.000	1100.00	1010.00	70.00
16.000		16.000	25.000	1100.00	1010.00	70.00
20.000		20.000	25.000	1100.00	1010.00	70.00
22.000		22.000	25.000	1100.00	1010.00	70.00

Availability
--------------



## Super fast gun drill service

Your tailor-made single-fluted EB 80 gun drills with brazed shank!  
Gühring's super quick gun drill offer makes it possible:  
Special tools within 10 working days!



Design options:

- nominal diameter 2.0 - 13.9 mm increasing by 0.1 mm
- nominal diameter 14.0 - 22.0 mm increasing by 0.5 mm
- total length up to 1200 mm, min. flute length 20xD
- head form G
- standard driver
- carbide grade K15
- bright with standard point grind for cast materials and aluminum
- S-coat (TiN) with chip breaking groove for long-chipping steels
- in combination with standard driver

enquiry form see page 53

## PCD corner tipped

Every solid carbide single-flute gun drill is available tipped with PCD,  
nominal diameter range 6.00 – 16.00 mm.

Your advantages of PCD corner tipping:

- up to 10 times longer tool life in aluminum
- minimal machine downtime
- no built-up edge in aluminum

Please talk to us!







ZB 80

## THE SPECIALIST FOR CAST IRON

- two-fluted gun drills with brazed carbide head
- nominal diameter from 6.00 to 30.00 mm
- perfect for GG25, GGG40, GGK
- extremely large cooling ducts
- optimized point geometry

# Two-fluted gun drills ZB 80

Standard	Type	Tool illustration	Drilling depth	Tool material	Surface finish	Diameter range	Gühring no.	Discount group	Standard range page
Two-fluted gun drills ZB 80									
Gühring std.	ZB 80	 Aluminium	30 x D	<b>Carbide</b>	○	8.000 - 12.000	<b>5019</b>	123	29
Gühring std.	ZB 80	 Cast materials	30 x D	<b>Carbide</b>	○	8.000 - 12.000	<b>5643</b>	123	29



**Point grind for cast materials**



**Point grind for aluminium**

# Two-fluted gun drills ZB 80

<b>Guhring no.</b>	<b>5019</b>	<b>5643</b>
<b>Standard</b>	<b>Guhring standard</b>	
<b>Tool material</b>	<b>Carbide</b>	
<b>Carbide grade</b>	<b>K15</b>	<b>K 15</b>
<b>Surface finish</b>	○	○
<b>Drilling depth</b>	<b>30 x D</b>	<b>30 x D</b>
<b>Cutting direction</b>	<b>right-hand</b>	<b>right-hand</b>
<b>Tolerance</b>	<b>h5</b>	<b>h5</b>
<b>Discount group</b>	<b>123</b>	<b>123</b>

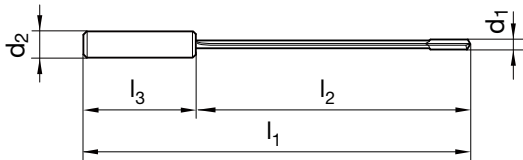

Code	d1	d2	l1	l2	l3
no.	mm	mm	mm	mm	mm
8,000	8,000	16,000	330,00	280,00	48,00
10,000	10,000	20,000	390,00	340,00	50,00
12,000	12,000	20,000	450,00	400,00	50,00

Availability	
●	●
●	●
●	●

# Two-fluted gun drills ZB 80

**Suitable for cast iron, aluminium and short-chipping non-ferrous metals**



ex-stock range from Ø 8.0 to 12.0 mm for drilling depths up to 30 x D  
 special solutions from Ø 6.0 to 30.0 mm, max. total length 1000 mm  
 enquiry form see page 54

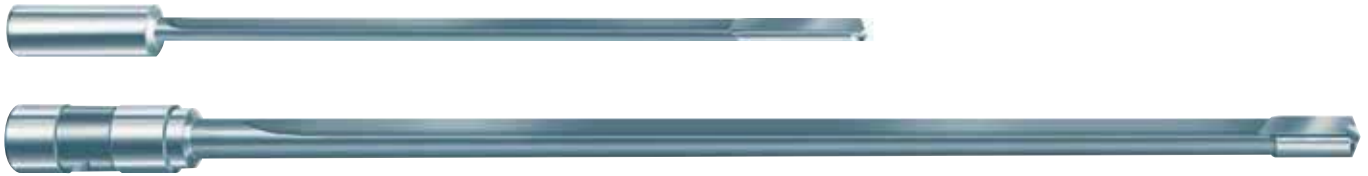

**F** FIRE      **a** TiAlN nanoA

For certain materials a coating is required, as the successful application of gun drills with a bright surface finish cannot be guaranteed.  
 Coating definition see GuhringNavigator.

## The dimensions required to calculate the length for conventional machine tools

\* max. flute length per tool 40 x D, for larger drilling depths apply two tools. (i.e. Ø 10 x 450 and Ø 9.95 x 850 mm)

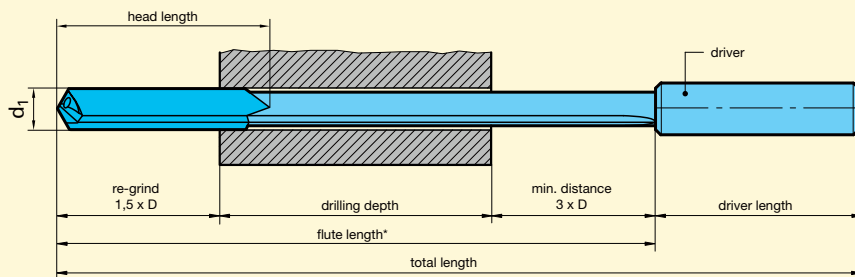

## ZB 80

### Standard point grinds

(special point grinds available)

Point grind G  
for machining  
cast iron

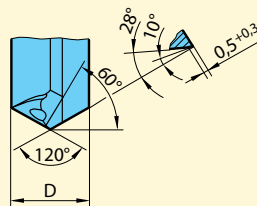

Point grind A  
for machining  
aluminium

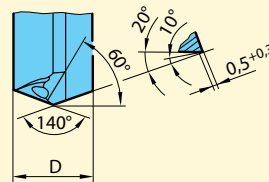

## ZB 80

### Special point grinds, e.g.:

Aluminium

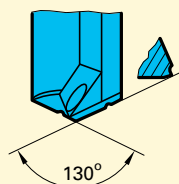

Cast iron

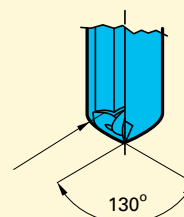



# EB 800

## THE FLEXIBLE

- single-fluted gun drills with interchangeable inserts and guide pads
- nominal diameter from 12.00 to 52.00 mm
- convertible by 0.5 mm per basic body range
- any combination of carbide grades and coatings possible
- suitable for almost all materials



# Single-fluted gun drills EB 800

Special solutions from Ø 12.0 to 52.0 mm, total length max. 3000 mm

Size	Diameter holder range	Body/holder	Insert									
			Inserts (external)				Screws	Screw driver				
			TiN-coated	FIRE-coated	Signum-coated	TiAlN nanoA-coated						
0.	Ø12.00 - Ø12.49 Ø12.50 - Ø12.99 Ø13.00 - Ø13.49 Ø13.50 - Ø13.99 Ø14.00 - Ø14.49 Ø14.50 - Ø14.99 Ø15.00 - Ø15.49 Ø15.50 - Ø15.99	Body/holder especially to customer requirements. Total length up to 3000mm. flute length from 15xD  Alternative: Standard range Guhring no. 5644 from diameter 12.00mm up to 24.00mm in preferred sizes complete with TiN inserts and TiN guide pads	Guh. no. 5029 + nom.-Ø = order no.	Guh. no. 5704 + nom.-Ø = order no.	Guh. no. 5702 + nom.-Ø = order no.	Guh. no. 5706 + nom.-Ø = order no.	Guh. no. 4071 2.502 T8 M2.5x 5.2	Guh. no. 1612 8.001				
	1.						Ø16.00 - Ø16.49 Ø16.50 - Ø16.99 Ø17.00 - Ø17.49 Ø17.50 - Ø17.99 Ø18.00 - Ø18.49 Ø18.50 - Ø18.99 Ø19.00 - Ø19.49 Ø19.50 - Ø19.99	Guh. no. 4071 3.002 T9 M3x6.4	Guh. no. 1612 9.001			
2.							Ø20.00 - Ø20.49 Ø20.50 - Ø20.99 Ø21.00 - Ø21.49 Ø21.50 - Ø21.99 Ø22.00 - Ø22.49 Ø22.50 - Ø22.99 Ø23.00 - Ø23.49 Ø23.50 - Ø23.99 Ø24.00 - Ø24.49 Ø24.50 - Ø24.99 Ø25.00 - Ø25.49 Ø25.50 - Ø25.99	Guh. no. 4071 4.001 T15 M4x7.7	Guh. no. 1612 15.001			
	3.						Ø26.00 - Ø26.49 Ø26.50 - Ø26.99 Ø27.00 - Ø27.49 Ø27.50 - Ø27.99 Ø28.00 - Ø28.49 Ø28.50 - Ø28.99 Ø29.00 - Ø29.49 Ø29.50 - Ø29.99	Guh. no. 4071 4.002 T15 M4x10.6				
4.							Ø30.00 - Ø30.49 Ø30.50 - Ø30.99 Ø31.00 - Ø31.49 Ø31.50 - Ø31.99 Ø32.00 - Ø32.49 Ø32.50 - Ø32.99 Ø33.00 - Ø33.49 Ø33.50 - Ø33.99	Guh. no. 4071 5.002 T20 M5x14.2	Guh. no. 1612 20.001			
	5.						Ø34.00 - Ø34.49 Ø34.50 - Ø34.99 Ø35.00 - Ø35.49 Ø35.50 - Ø35.99 Ø36.00 - Ø36.49 Ø36.50 - Ø36.99 Ø37.00 - Ø37.49 Ø37.50 - Ø37.99					
6.							Ø38.00 - Ø38.49 Ø38.50 - Ø38.99 Ø39.00 - Ø39.49 Ø39.50 - Ø40.00	Guh. no. 4071 3.002 TX9 M3x6.4	Guh. no. 1612 9.001			
	7.						Ø40.01 - Ø40.49 Ø40.50 - Ø40.99 Ø41.00 - Ø41.49 Ø41.50 - Ø41.99 Ø42.00 - Ø42.49 Ø42.50 - Ø42.99 Ø43.00 - Ø43.49 Ø43.50 - Ø43.99					
8.							Ø44.00 - Ø44.49 Ø44.50 - Ø44.99 Ø45.00 - Ø45.49 Ø45.50 - Ø45.99 Ø46.00 - Ø46.49 Ø46.50 - Ø46.99 Ø47.00 - Ø47.49 Ø47.50 - Ø47.99	Special drill ex-stock	Special drill ex-stock	Special drill ex-stock	Special drill ex-stock	Guh. no. 4071 4.001 TX15 M4x7.7
	9.						Ø48.00 - Ø48.49 Ø48.50 - Ø48.99 Ø49.00 - Ø49.49 Ø49.50 - Ø49.99 Ø50.00 - Ø50.49 Ø50.50 - Ø50.99 Ø51.00 - Ø51.49 Ø51.50 - Ø52.00				Guh. no. 4071 4.002 TX15 M4x10.6	



# Single-fluted gun drills EB 800

Inserts (internal)	Screws	Screw driver	Guide pads				Screws	Screw driver
			TiN-coated	FIRE-coated	Signum-coated	TiAlN nanoA-coated		
							Guh. no. 4071 1.601 T5 M1.6x4.4	Guh. no. 1612 5.001
							Guh. no. 4071 2.203 T7 / M2.2x 4.6	Guh. no. 1612 7.001
							Guh. no. 4071 2.202 T7 / M2.2x5.6	
							Guh. no. 4071 2.502 T8 M2.5x 5.2	Guh. no. 1612 8.001
			Guh. no. 5030 + nom.-Ø = order no.	Guh. no. 5705 + nom.-Ø = order no.	Guh. no. 5703 + nom.-Ø = order no.	Guh. no. 5707 + nom.-Ø = order no.	Guh. no. 4071 2.501 T8 M2.5x6.4	
<b>bright</b> Special drill ex-stock  <b>TiN</b> Special drill ex-stock  <b>FIRE</b> Special drill ex-stock	Guh. no. 4071 4.501 T15 M4.5x11.8	Guh. no. 1612 15.001	Special drill ex-stock	Special drill ex-stock	Special drill ex-stock	Special drill ex-stock	Guh. no. 4071 3.003 T9 M3x8	Guh. no. 1612 9.001

# Single-fluted gun drills EB 800

## NEW:

- now also available up to nom. dia. 52.00 mm as a special option
- inserts and guide pads in 1/10 diameters as standard, in 1/100 diameters as special tools with fixed additional charges
- enquiry form see page 55



Guhring single-fluted gun drills with interchangeable inserts and guide pads are also produced as special tools according to customer requirements. They are suitable for nearly every material and available from diameter 16.0 to 52.0 mm up to a maximum total length of 3000 mm.

Your special advantages are:

- The interchangeable component technology for inserts and guide pads makes any combination of carbide grade and coating possible.
- The precision interchangeable inserts and guide pads eliminate complicated adjustments.
- The precision guide pads are produced in a special carbide for your individual deep drilling task. They can be reverse-fitted, providing double tool life. In addition, they can be provided with any of the Guhring coatings.
- Thanks to the precision insert seatings and the interchangeable inserts there is only a small number of interchangeable components. The tool is therefore extremely rigid.
- Expensive stoppages are eliminated because the worn

components can be replaced without removing the tool from the machine.

- The expensive re-grinding process is eliminated thanks to the interchangeable insert technology.
- The application orientated selection of the most suitable interchangeable insert always ensures optimal chip breaking – even in problematic materials.
- Specifically optimised to your individual deep drilling task, the precision inter-changeable inserts are also produced in a special carbide. In addition, all Guhring coatings are available.
- Within the diameter range it is possible to modify the nominal diameter at any time by simply interchanging the individual components.
- The driver is produced in heat-treatable steel acc. to:
  - DIN 6535 HA            - DIN 6535 HE
  - DIN 6535 HB           - DIN 1835 E

Also, all the forms generally required for deep drilling machines are possible to be manufactured.

Ex-stock range from from Ø 12.0 to 24.0 mm suitable for almost every material

<b>Guhring no.</b>	<b>5644</b>
<b>Standard</b>	<b>Guhring std.</b>
<b>Tool material</b>	<b>Carbide</b>
<b>Carbide grade</b>	<b>K20/K40</b>
<b>Surface finish</b>	<b>Ⓢ</b>
<b>Type</b>	<b>EB 800</b>
<b>Drilling depth</b>	<b>30xD</b>
<b>Cutting direction</b>	<b>right-hand</b>
<b>Tolerance</b>	<b>h8</b>
<b>Discount group</b>	<b>123</b>

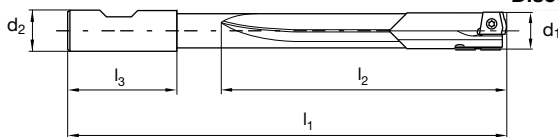

d1		d2	l1	l2	l3
mm	inch	mm	mm	mm	mm
12.000		20.000	446.00	384.00	50.00
12.700	1/2	20.000	468.00	384.00	50.00
14.000		20.000	510.00	448.00	50.00
15.000		25.000	548.00	480.00	56.00
16.000		25.000	580.00	512.00	56.00
18.000		25.000	644.00	576.00	56.00
20.000		32.000	712.00	640.00	60.00
24.000		32.000	840.00	768.00	60.00

Availability
●
●
●
●
●
●
●
●

**Attention: - shortest flute length 15 x D  
- possible diameter tolerance IT9/IT10**

Drawing, all Guhring nos. and specifications included with every quote.

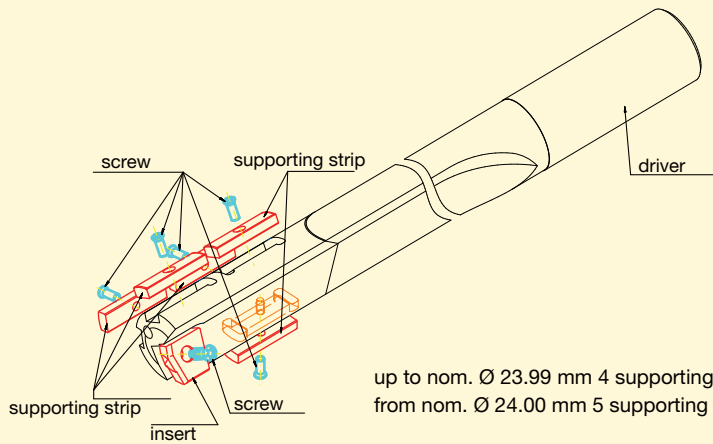

up to nom. Ø 23.99 mm 4 supporting strips  
from nom. Ø 24.00 mm 5 supporting strips

**Guhring KG**  
Herderstrasse 50-54  
D-72458 Albstadt  
Tel. +49 74 31 17-0  
Fax +49 74 43 17-21 279

**Gun drills**  
with interchangeable insert and  
supporting strip, internal cooling  
Diameter range: 12.00 mm - 52.00 mm



Even modern high-performance tools will wear at some point due to the enormous stresses they have to withstand. Guhring re-produces the tool performance thanks to professional re-grinding.

Gun drills with brazed carbide heads can be re-ground up to ten times. With heavy wear or damage the carbide heads are re-tipped. Either way the tool body remains intact.

Thanks to the installation of identical machines and equipment in all re-grind centres a universal standard is ensured for gun drills of the highest quality - world-wide.

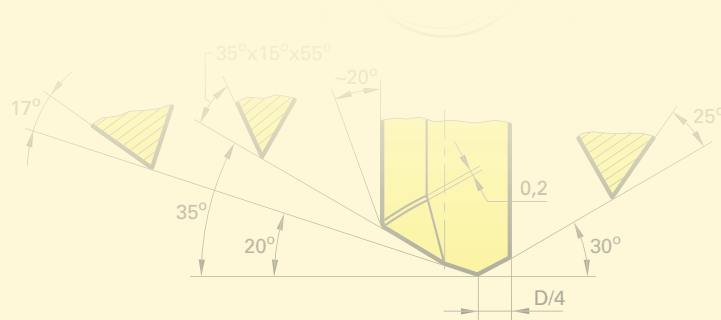

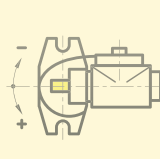
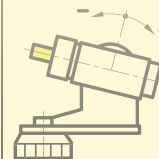
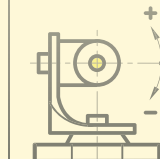
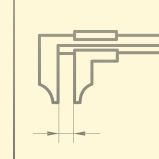
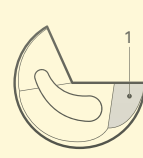
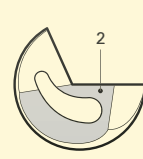
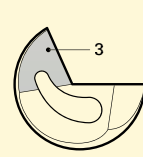
				
	- 25°	+ 25°	0°	
	+ 20°	+ 17°	0°	D/4
	+ 35°	+ 15°	+ 55°	



# GRINDING EQUIPMENT AND ACCESSORIES

ACCESSORIES

## Grinding machine TBM 116 for single-fluted gun drills

TBM 116 is a manually operated, universal grinding machine. Its compact design combined with Guhring's single-fluted gun drill grinding system and Guhring's double grinding wheel makes this a perfect unit to re-grind single-fluted gun drills. It is especially suitable for the re-grinding of a small to medium number of items of varying diameters and lengths. Furthermore, it also allows the fairly simple addition of transverse chip breakers to single-fluted gun drills as well as other modifications.

### Supplied items:

Grinding machine with two high-powered light units as well as two 220 V sockets (grinding system and grinding wheel not included).

### Machine data:

Input power requirements 380 V/50 Hz, Grinding wheel 2850 rev./min, Max. diameter of grinding wheel 150 mm.

**Guhring No.:** 600 127 170



## Grinding machine TBV 116 for single-fluted gun drills for Ø 3 to 30 mm

The fixture is designed for the re-grinding of single-fluted gun drills in the diameter range from 3 mm to 30 mm. It is ideally suitable for standard and special point grinds. A minimum flute length is of no importance thanks to a short center sleeve. In addition, the fixture is supplied with a supporting bar for long tools. TBV 116 is therefore truly universal and can be applied on any commercial, manual tool grinding machine.

**With TBV 116 we recommend our double grinding wheel DSS 125.**

### Attention:

Single-fluted gun drills have a flute spacing angle of 120° and can therefore not be clamped in a collet in a separate unit. You could possibly destroy the tool.

**Guhring No.:** 600 127 171



## Double grinding wheel DSS 125

The DSS double grinding wheel is a firmly clamped and balanced grinding wheel set. It consists of a rough outer diamond disc, with which the main proportion of wear is removed and a fine diamond disc that then gives a good finish to the cutting edges. It is advisable to use a cleaning stone from time to time remove any grinding dust, otherwise too much heat is created and the carbide cutting edge destroyed.

### The DSS 125 consists of:

- an outer disc Ø 125 mm, coating width 10 mm, coating thickness 3 mm, hole Ø 20 mm, grade D 126,
- an inner disc Ø 75 mm, coating width 10 mm, coating thickness 2 mm, hole Ø 20 mm, grade D 46

**Guhring No.:** 400 110 098



## Grinding machine TBV 216 for single-fluted gun drills for Ø 1 to 6 mm

The new TBV 216 universal grinding fixture for small diameter single-fluted gun drills from 1.0 to 6.0 mm and a maximum length of 350 mm is simple to handle and enables the re-grinding or modifying of single-fluted gun drills in only four operations. Grinding is achieved with a 3-axis swivel mechanism, enabling the grinding of various point angles. It is possible to adjust and if necessary correct any angle individually.

**We recommend the application of our single grinding wheel ESS 125.**

### Supplied items:

- A set of guide bushes with the diameters 1.0 / 1.5 / 2.0 / 2.5 / 3.0 / 3.5 mm
- Various adaptors
- Centering microscope
- Spotlight and magnifier

**Guhring No.:** 600 132 346



## Single grinding wheel ESS 125

The ESS 125 grinding wheel is a fine diamond wheel that gives the cutting edges a good finish. It is advisable to remove the grinding dust from the wheel with a cleaning stone from time to time, otherwise too much heat is created destroying the carbide cutting edge.

### The ESS 125 consists of:

- a disc Ø 125 mm, coating width 10 mm, coating thickness 3 mm, hole Ø 20 mm, grade D 25

**Guhring No.:** 400 119 203



# Accessories for gun drilling machines

In contrast to conventional machine tools, certain accessories, i.e. drilling bushes, seal discs, whipguide bushes etc., are part of the standard equipment on deep hole drilling machines. A selection of these products for the current dimensions you will find on the following pages.



## Drilling bushes

Order no. = Guhring no. + code no.

Guhring no.	5747	5748
Standard	Guhring standard	Guhring standard
Tool material	HSS	Solid carbide
Discount group	123	123

Minimum order quantity 3 pieces      Minimum order quantity 3 pieces

Code no.	d1 mm	d2 mm	l1 mm	Availability	
0,900-0,999	0.900-0.999	3.00	9.00	●	●
1,000-1,899	1.000-1.899	4.00	9.00	●	●
1,900-2,699	1.900-2.699	5.00	9.00	●	●
2,700-3,399	2.700-3.399	6.00	12.00	●	●
3,400-4,099	3.400-4.099	7.00	12.00	●	●
4,100-5,099	4.100-5.099	8.00	12.00	●	●
5,100-6,099	5.100-6.099	10.00	16.00	●	●
6,100-8,099	6.100-8.099	12.00	16.00	●	●
8,100-10,099	8.100-10.099	15.00	20.00	●	●
10,100-12,099	10.100-12.099	18.00	20.00	●	●
12,100-15,099	12.100-15.099	22.00	28.00	●	●
15,100-18,099	15.100-18.099	26.00	28.00	●	●
18,100-22,099	18.100-22.099	30.00	36.00	●	●
22,100-26,099	22.100-26.099	35.00	36.00	●	●
26,100-30,099	26.100-30.099	42.00	45.00	●	●
30,100-35,099	30.100-35.099	48.00	45.00	●	●
35,100-40,000	35.100-40.000	55.00	56.00	●	●



# Adjustable screw without sealing element

Order no. = Guhring no. + code no.

Guhring no.

5754

Standard

Guhring standard

Discount group

123

Minimum order quantity 5 pieces

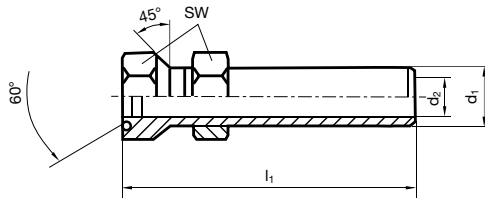

Code no.	d1 mm	d2 mm	l1 mm	l2 mm	l3 mm	SW mm
6,000	M6x0.5	3.50	26.00	3.20	5.00	9
10,000	M10x1.0	6.00	38.00	5.00	7.00	13
16,000	M16x1.5	10.00	57.00	8.00	10.00	22

Availability



# Adjustable screw with sealing element

Order no. = Guhring no. + code no.

Guhring no.

5755

Standard

Guhring standard

Discount group

123

Minimum order quantity 5 pieces

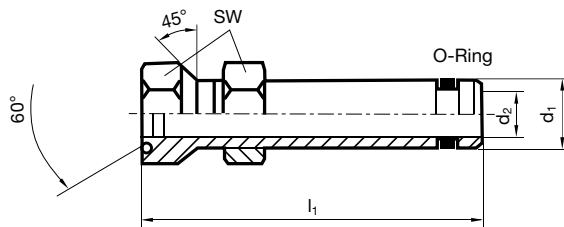

Code no.	d1 mm	d2 mm	l1 mm	l2 mm	l3 mm	SW mm	O-ring DIN 3770
6,000	M6x0.5	3.50	45.00	3.20	5.00	9	5x1.5
10,000	M10x1.0	6.00	50.00	5.00	7.00	13	8x2.0
16,000	M16x1.5	10.00	65.00	8.00	10.00	22	14x2.6
24,000	M24x1.5	16.00	90.00	12.00	15.00	30	20x3.0

Availability



Sealing discs and whipguide bushes, Guhring no. 5749, 5750, 5751, 5752 and 5753 always cover one nominal diameter range of the gun drills to be retained. When ordering, please always state the Guhring no. + the code no. from the following table!

## Assignment table code no. gun drill diameter for accessories

Code no.	For gun drills with nominal diameter d1		Code no.	For gun drills with nominal diameter d1	
	from mm	to mm		from mm	to mm
<b>1,900</b>	2.000	2.099	<b>9,400</b>	9.700	9.999
<b>2,000</b>	2.100	2.199	<b>9,700</b>	10.000	10.299
<b>2,100</b>	2.200	2.299	<b>10,000</b>	10.300	10.799
<b>2,200</b>	2.300	2.399	<b>10,500</b>	10.800	11.299
<b>2,300</b>	2.400	2.499	<b>11,000</b>	11.300	11.799
<b>2,400</b>	2.500	2.599	<b>11,500</b>	11.800	12.399
<b>2,500</b>	2.600	2.699	<b>12,000</b>	12.400	12.899
<b>2,600</b>	2.700	2.799	<b>12,500</b>	12.900	13.399
<b>2,700</b>	2.800	2.899	<b>13,000</b>	13.400	13.899
<b>2,800</b>	2.900	3.099	<b>13,500</b>	13.900	14.399
<b>3,000</b>	3.100	3.359	<b>14,000</b>	14.400	14.899
<b>3,200</b>	3.360	3.459	<b>14,500</b>	14.900	15.399
<b>3,300</b>	3.460	3.559	<b>15,000</b>	15.400	15.899
<b>3,400</b>	3.560	3.799	<b>15,500</b>	15.900	16.399
<b>3,600</b>	3.800	3.959	<b>16,000</b>	16.400	16.899
<b>3,700</b>	3.960	4.259	<b>16,500</b>	16.900	17.399
<b>4,000</b>	4.260	4.499	<b>17,000</b>	17.400	17.899
<b>4,200</b>	4.500	4.749	<b>17,500</b>	17.900	18.399
<b>4,500</b>	4.750	4.999	<b>18,000</b>	18.400	19.509
<b>4,700</b>	5.000	5.249	<b>19,000</b>	19.510	20.509
<b>5,000</b>	5.250	5.499	<b>20,000</b>	20.510	21.509
<b>5,200</b>	5.500	5.749	<b>21,000</b>	21.510	22.609
<b>5,500</b>	5.750	5.999	<b>22,000</b>	22.610	23.609
<b>5,700</b>	6.000	6.249	<b>23,000</b>	23.610	24.609
<b>6,000</b>	6.250	6.449	<b>24,000</b>	24.610	25.609
<b>6,200</b>	6.450	6.749	<b>25,000</b>	25.610	26.609
<b>6,500</b>	6.750	6.999	<b>26,000</b>	26.610	27.609
<b>6,700</b>	7.000	7.299	<b>27,000</b>	27.610	28.609
<b>7,000</b>	7.300	7.599	<b>28,000</b>	28.610	29.609
<b>7,300</b>	7.600	7.799	<b>29,000</b>	29.610	30.609
<b>7,500</b>	7.800	7.999	<b>30,000</b>	30.610	32.609
<b>7,700</b>	8.000	8.299	<b>32,000</b>	32.610	34.699
<b>8,000</b>	8.300	8.699	<b>34,000</b>	34.700	36.699
<b>8,400</b>	8.700	8.999	<b>36,000</b>	36.700	38.699
<b>8,700</b>	9.000	9.299	<b>38,000</b>	38.700	40.000
<b>9,000</b>	9.300	9.699			

# Sealing disc for single-fluted gun drills

Order no. = Guhring no. + code no.	<b>Guhring no.</b>	<b>5752</b>	
	<b>Standard</b>	<b>Guhring standard</b>	
	<b>Discount group</b>	<b>123</b>	

Minimum order quantity 5 pieces

Code no.	d1 from... to... mm	d2 mm	l1 mm	Availability
see assignment table page 60	2.000-4.999	20.000	4.00	●
	5.000-15.399	32.000	4.00	●
	15.400-25.609	40.000	4.00	●
	26.610-40.000	90.000	4.00	●

**Order example:**  
- Sealing disc for diameter d1 = 26,500 is Guhring no. 5752 + code no. 25,000 = **order no. 5752 25,000**

# Sealing disc for double-fluted gun drills

Order no. = Guhring no. + code no.	<b>Guhring no.</b>	<b>5753</b>	
	<b>Standard</b>	<b>Guhring standard</b>	
	<b>Discount group</b>	<b>123</b>	

Minimum order quantity 5 pieces

Code no.	d1 from... to... mm	d2 mm	l1 mm	Availability
see assignment table page 60	5.400-15.399	32.000	4.00	●
	15.400-27.000	40.000	4.00	●

**Order example:**  
- Sealing disc for diameter d1 = 16,000 is Guhring no. 5753 + code no. 15,500 = **order no. 5753 15,500**

# Whipguide bushes for single- and two-fluted gun drills

**xx,xxx = code no. acc. to assignment table on page 42 (prefix 0 with 4-digit code no.)**

<b>Guhring no.</b>	<b>5749</b>
<b>Standard</b>	<b>Guhring standard</b>
<b>Discount group</b>	<b>123</b>

Minimum order quantity 5 pieces

Code no.	d1 from... to... mm	d2 mm	l1 mm	l2 mm
2xx,xxx	2.000-11.799	20.000	22.00	12.00
3xx,xxx	4.000-25.609	30.000	26.00	13.00
4xx,xxx	20.510-36.699	45.000	26.00	16.00

<b>Availability</b>
●
●
●

**Order examples:**

- Whipguide bush with dia. d2 = 20,000 mm for diam. d1 = 8,000 is Guhring no. 5749 + „2“+“0“code no. 7,700 = **order no. 5749 207,700**
- Whipguide bush with dia. d2 = 30,000 mm for diam. d1 = 17,000 is Guhring no. 5749 + „3“+ code no. 16,500 = **order no. 5749 316,500**
- Whipguide bush with dia. d2 = 45,000 mm for diam. d1 = 3,000 is Guhring no. 5749 + „4“+“0“code no. 2,800 = **order no. 5749 402,800**

# Formed whipguide bushes for single-fluted gun drills

**xx,xxx = code no. acc. to assignment table on page 42 (prefix 0 with 4-digit code no.)**

<b>Guhring no.</b>	<b>5750</b>
<b>Standard</b>	<b>Guhring standard</b>
<b>Discount group</b>	<b>123</b>

Minimum order quantity 5 pieces

Code no.	d1 from... to... mm	d2 mm	l1 mm	l2 mm
2xx,xxx	2.000-12.399	20.000	20.00	12.00
3xx,xxx	4.000-20.509	30.000	26.00	14.00
4xx,xxx	20.510-38.699	45.000	26.00	16.00

<b>Availability</b>
●
●
●

**Order examples:**

- Formed whipguide bush with dia. d2 = 20,000 mm for gun drill dia. d1 = 8,000 is Guhring no. 5750 + „2“+“0“code no. 7,700 = **order no. 5750 207,700**
- Formed whipguide bush with dia. d2 = 30,000 mm for gun drill dia. d1 = 17,000 is Guhring no. 5750 + „3“+ code no. 16,500 = **order no. 5750 316,500**
- Formed whipguide bush with dia. d2 = 45,000 mm for gun drill dia. d1 = 23,000 is Guhring no. 5750 + „4“+ code no. 22,000 = **order no. 5750 422,000**

# Formed whipguide bushes for two-fluted gun drills

**xx,xxx = code no. acc. to assignment table on page 42 (prefix 0 with 4-digit code no.)**

<b>Guhring no.</b>	<b>5751</b>
<b>Standard</b>	<b>Guhring standard</b>
<b>Discount group</b>	<b>123</b>

Minimum order quantity 5 pieces

Code no.	d1 from... to... mm	d2 mm	l1 mm	l2 mm
2xx,xxx	5.400-12.399	20.000	22.00	12.00
3xx,xxx	5.400-22.609	30.000	26.00	13.00
4xx,xxx	5.400-27.000	45.000	26.00	16.00

<b>Availability</b>
●
●
●

**Order examples:**

- Formed whipguide bush with dia. d2 = 20,000 mm for gun drill dia. d1 = 8,000 is Guhring no. 5751 + „2“+“0“code no. 7,700 = **order no. 5751 207,700**
- Formed whipguide bush with dia. d2 = 30,000 mm for gun drill dia. d1 = 17,000 is Guhring no. 5751 + „3“+ code no. 16,500 = **order no. 5751 316,500**
- Formed whipguide bush with dia. d2 = 45,000 mm for gun drill dia. d1 = 9,000 is Guhring no. 5751 + „4“+“0“code no. 8,700 = **order no. 5751 408,700**

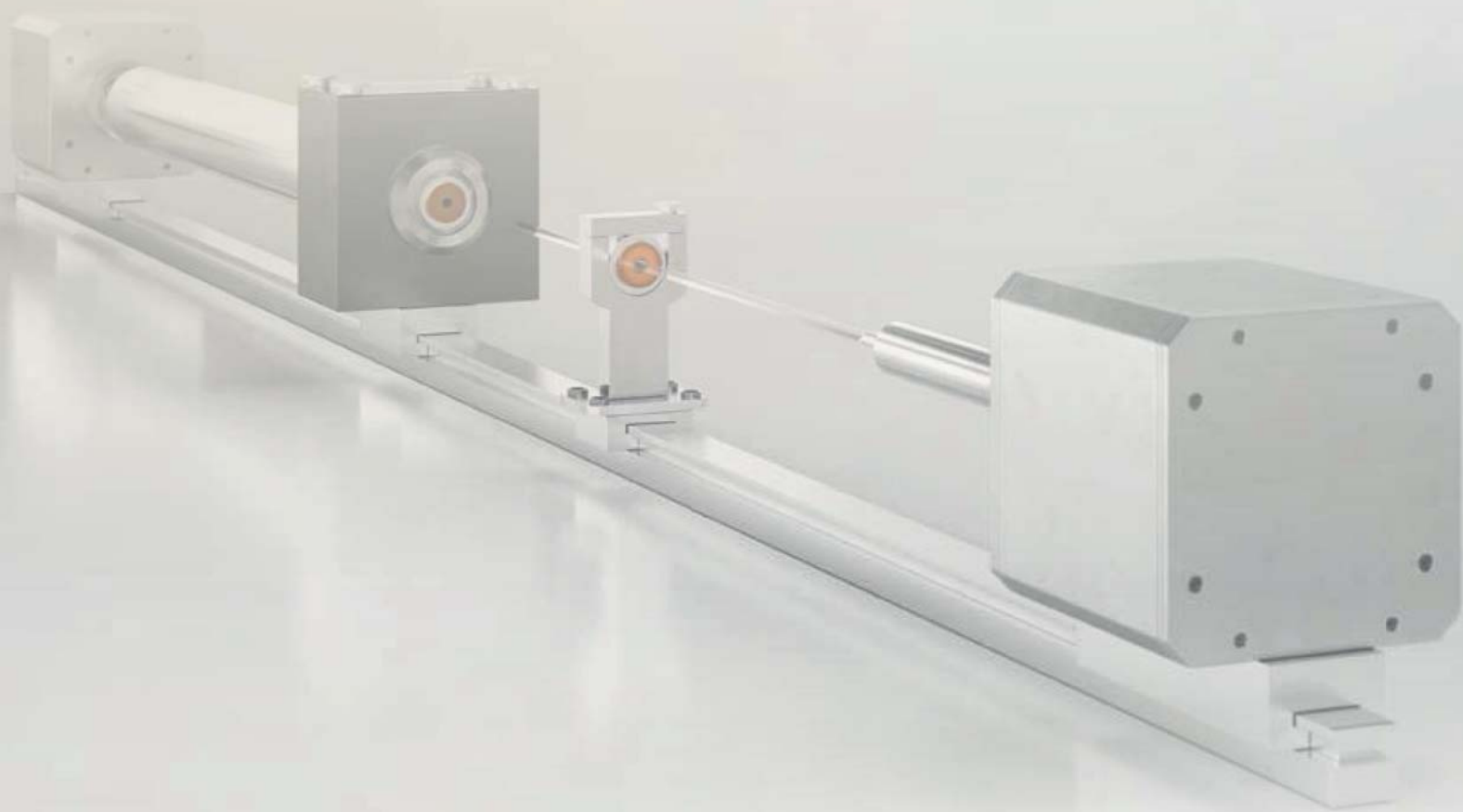

# TECHNICAL SECTION

TECHNICAL  
SECTION

Watch our movie title  
"Gun Drill"  
on Guhring TV under  
[www.youtube.com](http://www.youtube.com).

**Guhring TV**  
QR Code  
Scan and watch video!



# The drilling process

## A brief introduction to the subject of deep hole drilling

In the machining world, drilling depths of  $10 \times D$  and deeper are regarded as deep hole drilling operations, whereby smaller drilling depths can naturally also be produced with gun drills. Advantage is taken of the positive side effects, as for example good surface quality, low deviation from concentricity and optimised alignment accuracy.

### High pressure cooling - has become a matter of course.

In recent years, internal cooling has established itself for all drilling tools. Coolants are now living up to their name and being supplied via coolant ducts to where they are urgently required. Considerable improvements in tool life and less breakages have been achieved by this measure for twist drills, taps etc.

Every conventional machine tool currently on the market can be supplied with high pressure internal cooling and is therefore also suitable for deep hole drilling.

The share of gun drills on machining centres, lathes etc. is forever gaining more importance. The process is therefore increasing in popularity in the machining world.



All gun drills must have support for the pilot hole.

Gun drills must never operate at full speed without support in the machine shop.

Deep hole drilling is not a closed book, but can be mastered by anybody as long as certain conditions are adhered to.

Recommended cutting rates for the application of Guhring gun drills can be found on the pages for the individual types!

### Typical procedure with all gun drills on conventional machine tools:

- production of pilot hole ( $L = 3 \times D$ , tolerance H8)
- enter at low revolutions, approx. 200 rev./min, feed rate approx. 500 mm/min. With tools for drilling depths in excess than  $40 \times D$  enter the pilot hole revolving in left hand direction.
- At cutting speeds higher than 120 m/min we recommend to advance to final speed in several steps.
- setting of coolant pressure and revolutions
- uninterrupted drilling to required drilling depth without wood pecking. When applying gun drills with increased length-diameter-ratio, we recommend machining with reduced cutting parameters (approx. 75% of the optimal cutting speed) up to a drilling depth of approx. 25 mm.
- switching off coolant supply after reaching the required hole depth
- withdrawal in top gear with stationary spindle

### Application advice

- For drilling depths in excess than  $40 \times D$  we recommend the use of two or more gun drills, e. g.  $\varnothing 10 \times 400$  mm and  $\varnothing 9.95 \times 800$  mm.
- Gun drills for drilling depths of more than  $40 \times D$  should enter the pilot hole revolving in the left hand direction.
- When changing tools for drilling depths of more than  $40 \times D$ , the tool can be damped by switching on coolant supply for just one second.
- For machining of long-chipping materials we recommend the use of gun drills with polished flutes.
- Generally we recommend the use of soluble oil with a minimum oil content of 10 %.
- Single-fluted gun drills for long-chipping aluminium should be supplied with point grind  $180^\circ$  and coolant chamber.

### Deep hole drilling on conventional machine tools

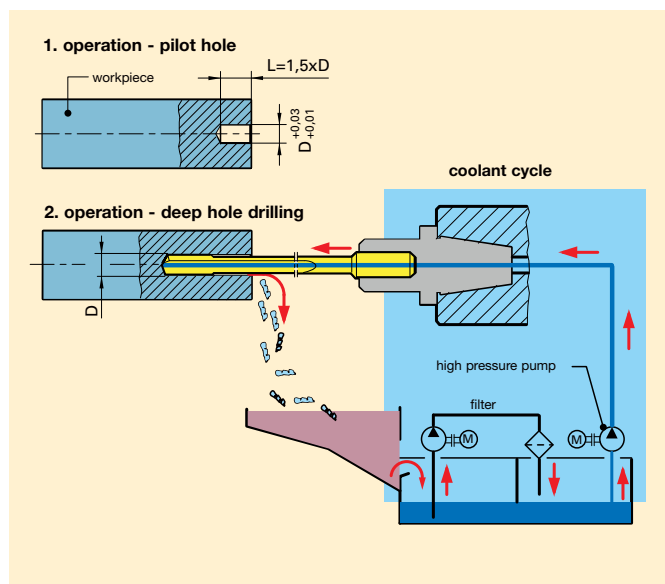

### Deep hole drilling machines

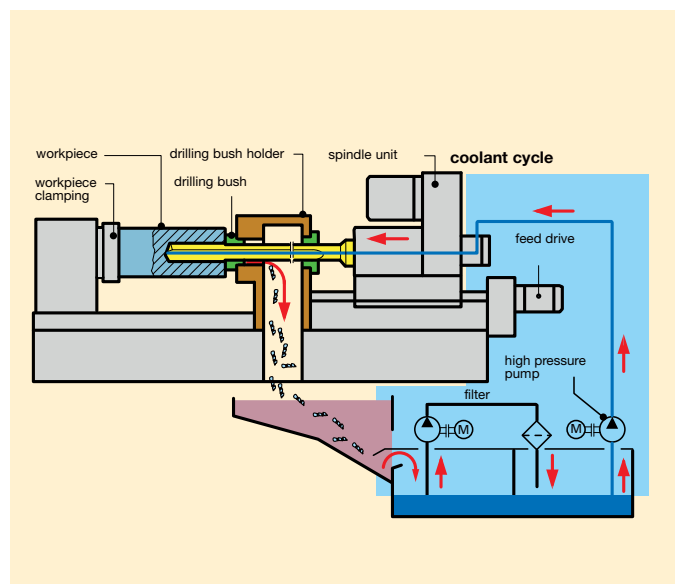

## Basic tolerances\*

The application of single-fluted gun drills can achieve a lower basic tolerance, as the cutting forces at the cutting edge are absorbed by the guide pads, unlike twist drills where the slightest deviation of the two cutting edges causes a larger hole.

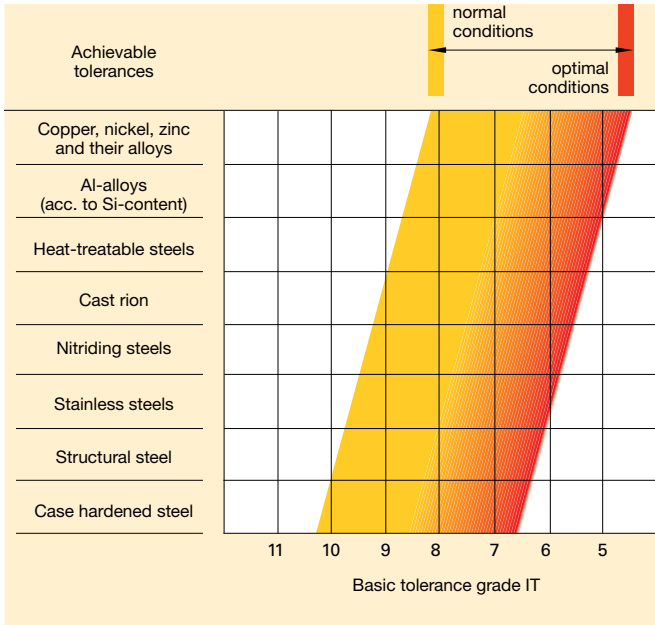

## Alignment accuracy\*

Because brazed single-fluted gun drills always have the precision carbide head brazed on to a flexible tube, the tool achieves very accurate aligned holes remaining unaffected by possible concentricity errors.

However, extreme material fluctuations and other influencing factors can impair the alignment accuracy.

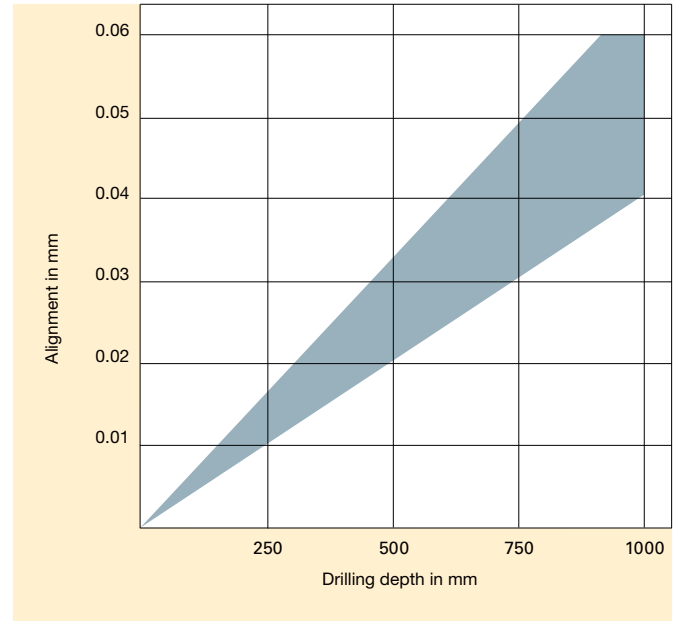

## Surface quality\*

The forces at the cutting edge are absorbed by the support bushes, which in return burnishes the surface.

Lubrication between the guide pads and hole surface is therefore very important.

The better the lubricant, the better the surface quality.

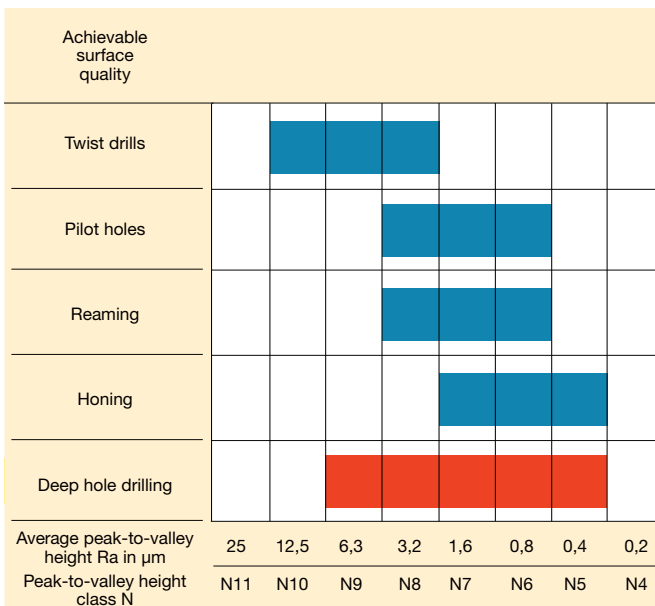

## Deviation from concentricity\*

When a hole is produced with, for example, a commercial twist drill, the quality of the point grind affects the concentricity of the hole. An imbalance of forces is created at the cutting edges. With gun drills, these cutting forces are absorbed by the guide pads, resulting in excellent concentricity.

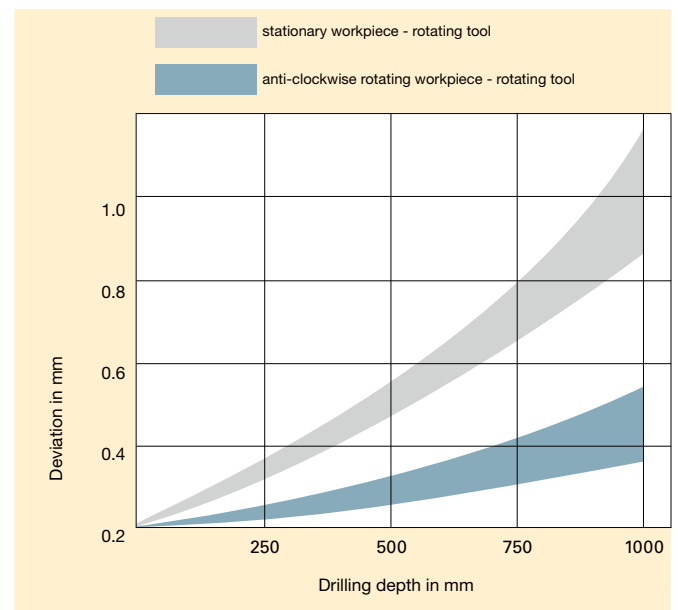

\* gun drills with two cutting edges – straight-fluted as well as spiral-fluted – achieve approx. 50% of the values stated

# Additional technical parameters

The range of drivers introduced below is available ex-stock. However, it only represents a small selection of drivers from our complete range. We naturally also produce

individual drivers of the highest precision to customer drawings. Attention! EB 100 requires drivers with positioning lugs. Further information on request.

## Drivers for deep drilling machines

**1**

code no.	d <sub>1</sub>	l <sub>1</sub>	l <sub>2</sub>	l <sub>3</sub>
1.1	10	40	24	-
1.2	10	40	24	45
1.3	10	40	24	55
1.4	16	45	31,2	-
1.5	25	70	34	-
1.6	25	70	34	78

**5**

code no.	d <sub>1</sub>	l <sub>1</sub>	l <sub>2</sub>
5.1	10	60	20
5.2	16	80	28
5.3	25	100	50
5.4	10	100	-
5.5	10	110	-

**2**

code no.	d <sub>1</sub>	l <sub>1</sub>	l <sub>2</sub>	l <sub>3</sub>
2.1	16	50	47	-
2.2	16	50	47	55
2.3	16	50	47	70

**6**

code no.	d <sub>1</sub>	l <sub>1</sub>
6.1	12.7	38
6.2	19.05	70
6.3	38.1	70

**3**

code no.	d <sub>1</sub>	l <sub>1</sub>	l <sub>2</sub>	l <sub>3</sub>
3.1	25	70	34	100

**7**

code no.	d <sub>1</sub>	l <sub>1</sub>	l <sub>2</sub>
7.1	16	112	73
7.2	20	126	82

**4**

code no.	d <sub>1</sub>	l <sub>1</sub>
4.1	19,05	70
4.2	12,70	70
4.3	25,40	70
4.4	31,75	70
4.5	38,10	70

## Drivers to DIN 1835

**9** form E

code no.	d <sub>1</sub>	l <sub>1</sub>
9.1	8	36
9.2	10	40
9.3	12	45
9.4	16	48
9.5	20	50
9.6	25	56
9.7	32	60
9.8	31.75	70
9.9	38.1	70
9.10	40	70

## Drivers to VDI draft

**12**

code no.	d <sub>1</sub>	l <sub>1</sub>
12.1	10	68
12.2	16	90
12.3	25	112

## Drivers to Speed-Bit-System

**13**

code no.	d <sub>1</sub>	l <sub>1</sub>	l <sub>2</sub>
13.1	16	40	16
13.2	25	50	25
13.3	35.6	60	-

## Drivers to DIN 6535

**10** form HA

code no.	d <sub>1</sub>	l <sub>1</sub>
10.1	8	36
10.2	10	40
10.3	12	45
10.4	16	48
10.5	20	50
10.6	25	56
10.7	32	60
10.8	25	70
10.9	40	70

## 8 form HB with code no. 8.6, 8.7, 8.8

code no.	d <sub>1</sub>	l <sub>1</sub>
8.1	8	36
8.2	10	40
8.3	12	45
8.4	16	48
8.5	20	50
8.6	25	56
8.7	32	60
8.8	40	70

## 11 form HE

code no.	d <sub>1</sub>	l <sub>1</sub>
11.1	8	36
11.2	10	40
11.3	12	45
11.4	16	48
11.5	20	50
11.6	25.4	70
11.7	25	56
11.8	32	60
11.9	40	70

## 16 similar form HA

code no.	d <sub>1</sub>	l <sub>1</sub>
16.1	10	50
16.2	16	64
16.3	20	70
16.4	25	81
16.5	32	92

## 17 2 DIN 332

code no.	d <sub>1</sub>	l <sub>1</sub>
17.1	19.05	70
17.2	25.40	70
17.3	31.75	70
17.4	38.1	70

### Driver variations to suit gun drill tubes

Solution for nom.-Ø < driver-Ø  
(difference must be appr. 6 mm):  
tube shank installed in driver

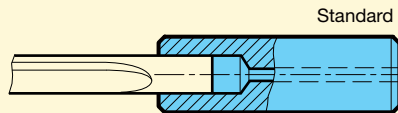

Solution for nom.-Ø ≠ driver-Ø  
(close to parallel):  
tube shank installed over spigot

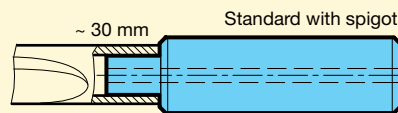

Solution for nom.-Ø > driver-Ø:  
tube shank installed over spigot,  
inside-Ø of tube shank > driver-Ø,  
tube shank fits against collar shoulder.

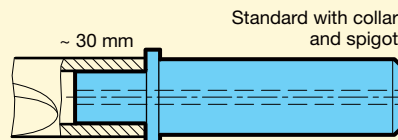



A close-up, slightly blurred photograph of a hand holding a pen and writing on a document. The background is a soft, out-of-focus mix of light colors, possibly a wall or a large sheet of paper. The lighting is warm and natural, creating a professional and focused atmosphere.

# ENQUIRY FORM

ENQUIRY FORM

# Questionnaire EB 100 with fixed flute length

Fax Enquiry / Order

simply photo-copy, complete and fax...

Enquiry

Order

Repeat order, no. of initial order

Gun drill:

EB 100



Quantity required: \_\_\_\_\_ tools

\*  $\varnothing$  0.9 - 12.0 mm

Flute length max. 500 mm

Total length and driver length are dependent  
on the driver selected, see page 48.

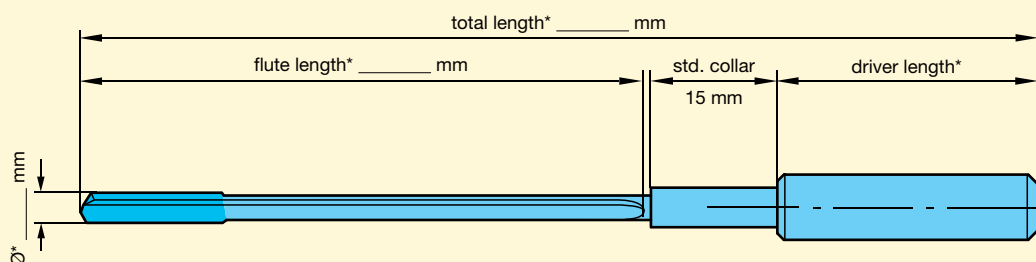

## Drawing of lay-out

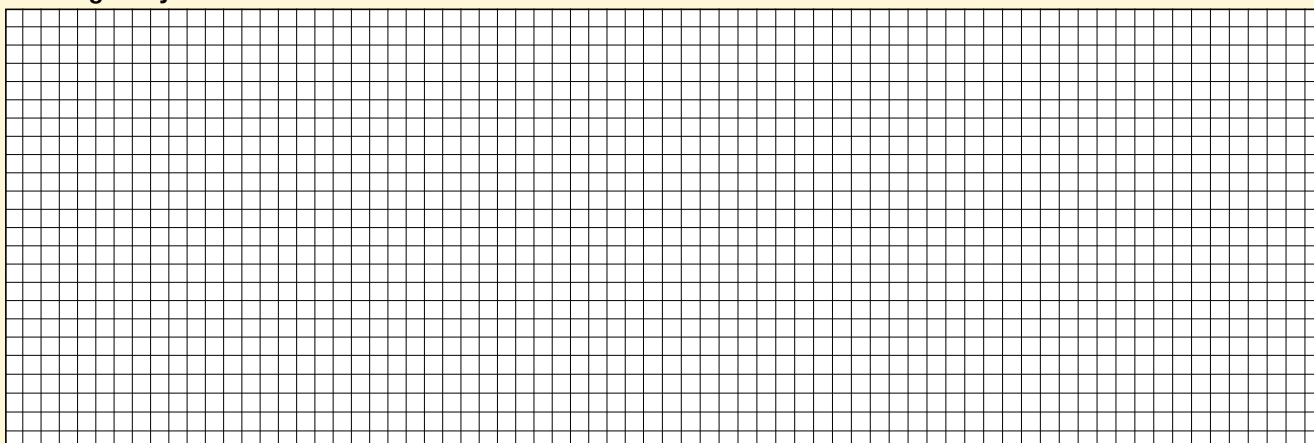

required in special cases only

Driver:

no

Code no. \_\_\_\_\_

to enclosed drawing

Coating:

TiN

Fire

TiAlN nanoA

TiAlN SuperA

\_\_\_\_\_

Workpiece:

Drilling depth: \_\_\_\_\_ Hole tolerance: \_\_\_\_\_ Material/designation: \_\_\_\_\_

Machine type:

Deep hole drilling machine

Conventional machine tool

Pilot hole

Drilling bush

Coolant:

Deep hole drilling oil

Soluble oil

Pressure \_\_\_\_\_ bar

Quantity \_\_\_\_\_ l/min

Company:

\_\_\_\_\_

Company stamp:

Telephone/fax:

\_\_\_\_\_

Contact:

\_\_\_\_\_

Signature:

\_\_\_\_\_

# Questionnaire EB 100 with fixed flute length

Fax Enquiry / Order  
simply photo-copy, complete and fax...

**Fast service**

- Enquiry     
  Order     
  Repeat order, no. of initial order

Gun drill:

EB 100 

Quantity required: \_\_\_\_\_ tools

\* Ø 0.9 - 12.0 mm  
 Flute length max. 500 mm  
 Total length and driver length are dependent  
 on the driver selected, see page 48.

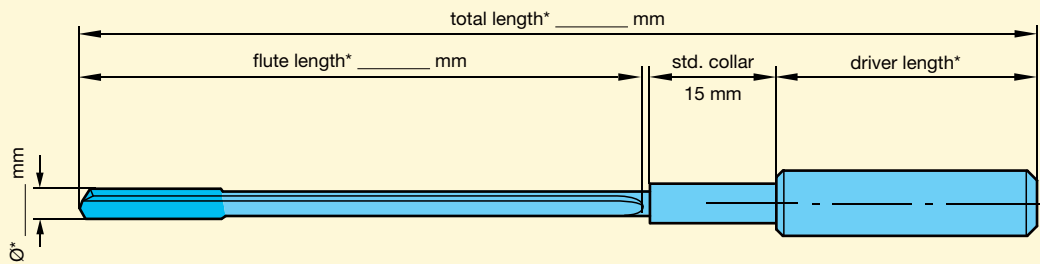



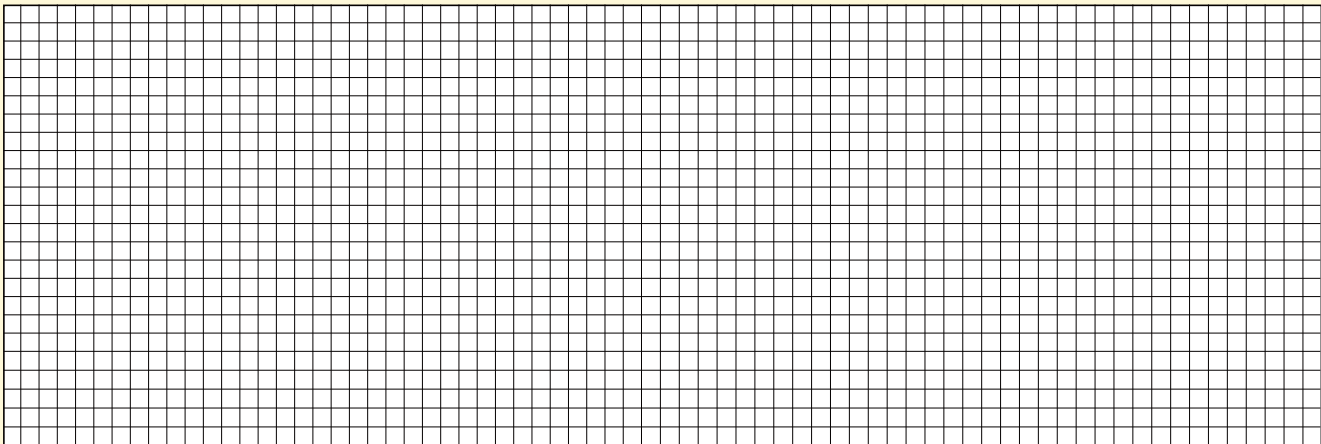

**Drawing of lay-out**



required in special cases only

**Driver:**     
  no     
  Code no. \_\_\_\_\_     
  to enclosed drawing

**Coating:**     
  TiN      
  Fire      
  TiAIN nanoA      
  TiAIN SuperA      
  \_\_\_\_\_

**Workpiece:**     
 Drilling depth: \_\_\_\_\_     
 Hole tolerance: \_\_\_\_\_     
 Material/designation: \_\_\_\_\_

**Machine type:**     
  Deep hole drilling machine     
  Conventional machine tool  
 Pilot hole     
 Drilling bush

**Coolant:**     
 Deep hole drilling oil     
 Soluble oil  
 Pressure \_\_\_\_\_ bar     
 Quantity \_\_\_\_\_ l/min

**Company:** \_\_\_\_\_     
 Company stamp: \_\_\_\_\_

**Telephone/fax:** \_\_\_\_\_

**Contact:** \_\_\_\_\_     
 Signature: \_\_\_\_\_

# Questionnaire EB 80 special solutions

Fax Enquiry / Order

simply photo-copy, complete and fax...

Enquiry

Order

Repeat order, no. of initial order

Gun drill:

EB 80



Quantity required: \_\_\_\_\_ tools

\* Ø 2.0 - 40.0 mm

Total length max. 3000 mm

Total length, flute length and driver length are dependent on the driver selected, see page 48.

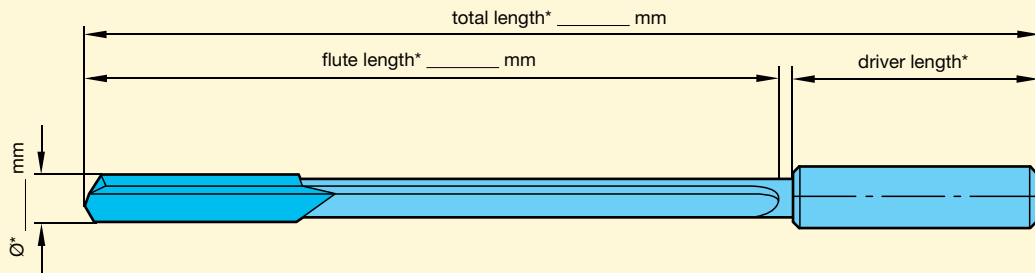

### Drawing of lay-out

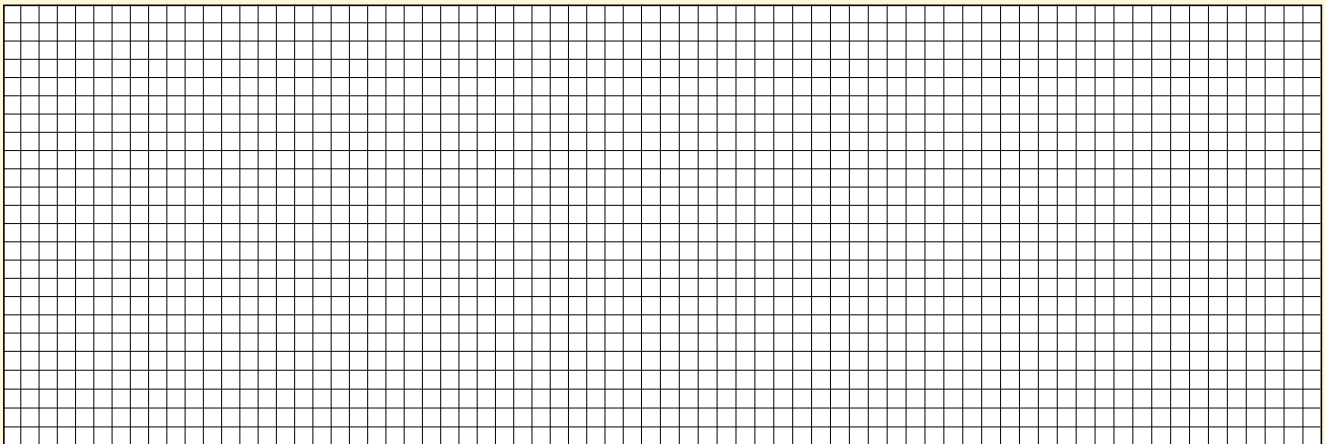

required in special cases only

Driver:

no

code no. \_\_\_\_\_

to enclosed drawing

Coating:

TiN

Fire

TiCN

Signum

\_\_\_\_\_

Workpiece:

Drilling depth: \_\_\_\_\_ Hole tolerance: \_\_\_\_\_ Material/designation: \_\_\_\_\_

Machine type:

Deep hole drilling machine

Conventional machine tool

Pilot hole

Drilling bush

Coolant:

Deep hole drilling oil

Soluble oil

Pressure \_\_\_\_\_ bar

Quantity \_\_\_\_\_ l/min

Company: \_\_\_\_\_

Company stamp: \_\_\_\_\_

Telephone/fax: \_\_\_\_\_

Contact: \_\_\_\_\_

Signature: \_\_\_\_\_

# Questionnaire EB 80 fast service

Fax Enquiry / Order  
simply photo-copy, complete and fax...

**Fast service**

- Enquiry     
  Order     
  Repeat order, no. of initial order

Gun drill:

EB 80



Quantity required: \_\_\_\_\_ tools

- \* Ø 2.0 – 13.9 mm in increments of 0.1 mm, head form G,
  - Ø 4.0 – 13.9 mm in increments of 0.1 mm, head form C,
  - Ø 14.0 – 22.0 mm in increments of 0.5 mm, head form G and C,
- Total length max. ≤ Ø 7,5 mm 650 mm, > Ø 7,5 mm 1200 mm, flute length min. 20 x D.  
Total length, flute length and driver length are dependent on the driver selected,  
see page 48.

In addition to metric dimensions FRACTIONAL sizes are also available as part of our fast service!

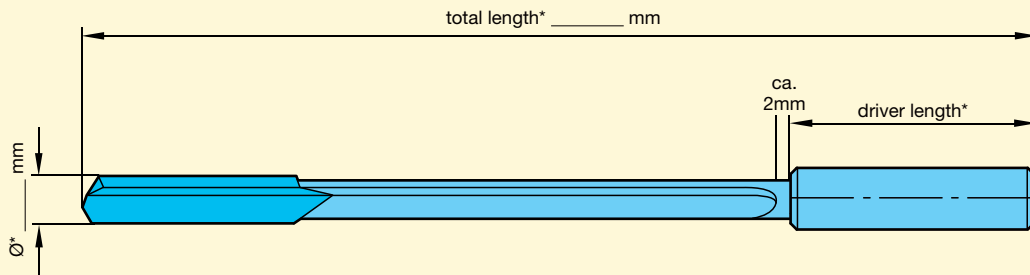

**Drawing of lay-out**

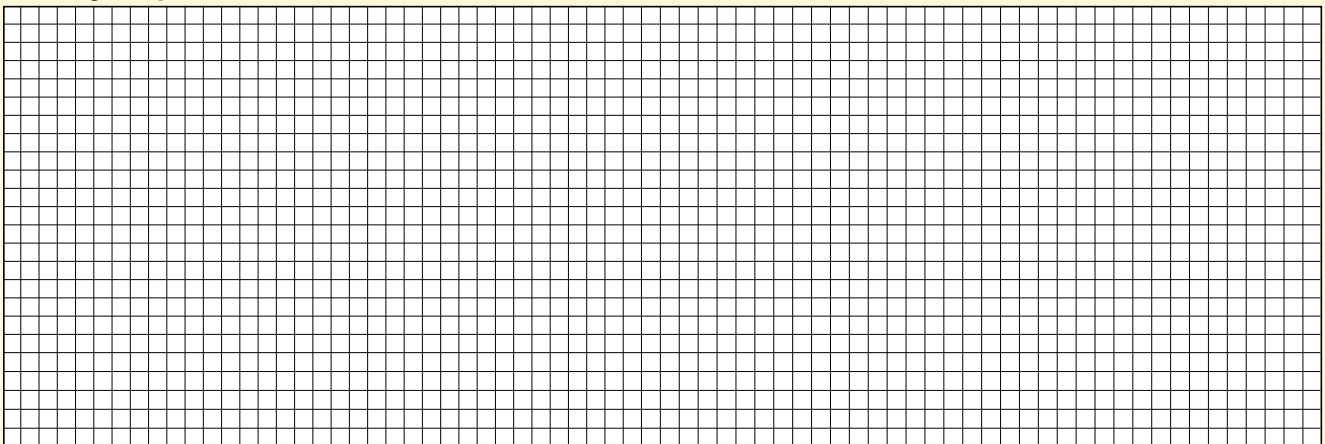

required in special cases only

- Driver:**           
  no           
  code no. \_\_\_\_\_
- Coating:**           
  TiN   
  Fire   
  TiAlN nanoA   
  TiAlN SuperA   
  Signum   
  \_\_\_\_\_
- Machine type:**           
  Deep hole drilling machine           
  Conventional machine tool  
 Pilot hole                                   
  Drilling bush
- Coolant:**           
  Deep hole drilling oil           
  Soluble oil  
 Pressure \_\_\_\_\_ bar                   
 Quantity \_\_\_\_\_ l/min

Company: \_\_\_\_\_

Company stamp:

Telephone/fax: \_\_\_\_\_

Contact: \_\_\_\_\_

Signature: \_\_\_\_\_

Fax Enquiry / Order  
 simply photo-copy, complete and fax...

Enquiry

Order

Repeat order, no. of initial order

**Gun drill:**

ZB 80



Quantity required: \_\_\_\_\_ tools

\* Ø 6.0 - 27.0 mm  
 Total length max. 1000 mm  
 Total length, flute length and driver length  
 are dependent on the driver selected,  
 see page 48.

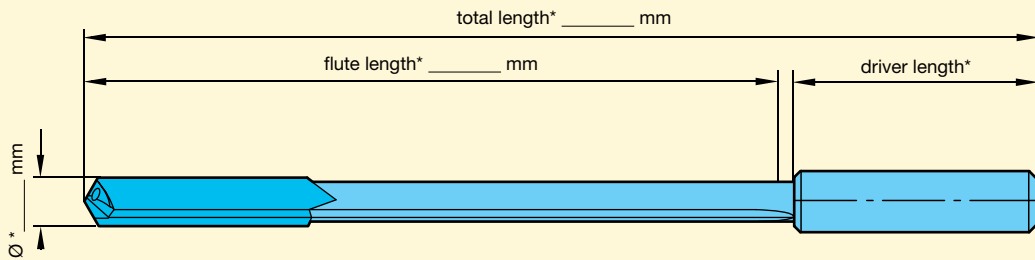

### Drawing of lay-out

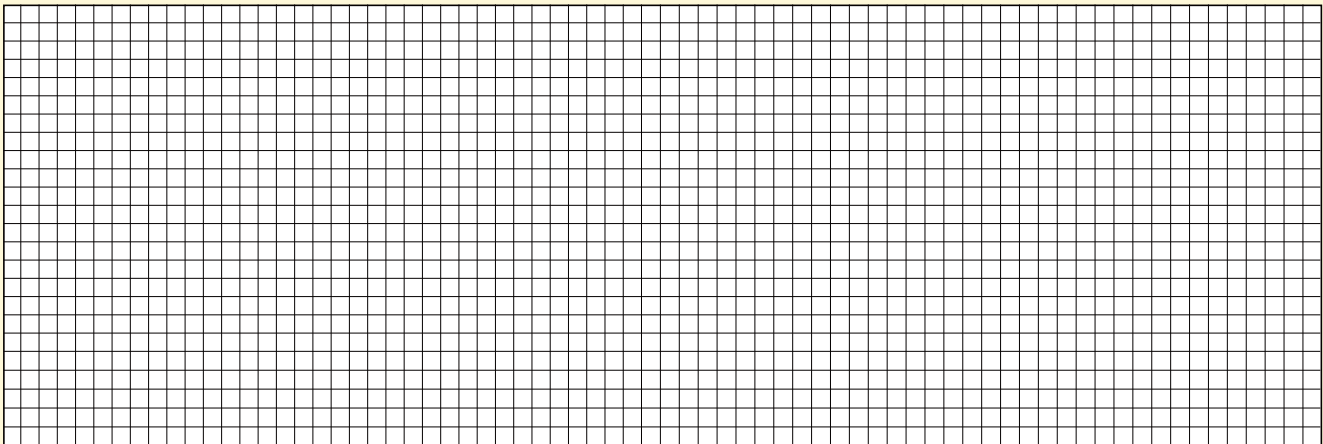

required in special cases only

**Driver:**

no      code no. \_\_\_\_\_      to enclosed drawing

**Coating:**

TiAlN nanoA **(a)**     FIRE **(F)**     bright     \_\_\_\_\_

**Workpiece:**

**Drilling depth:** \_\_\_\_\_    **Hole tolerance:** \_\_\_\_\_    **Material/designation:** \_\_\_\_\_

**Machine type:**

Deep hole drilling machine      Conventional machine tool  
 Pilot hole      Drilling bush

**Coolant:**

Deep hole drilling oil      Soluble oil  
 Pressure \_\_\_\_\_ bar     Quantity \_\_\_\_\_ l/min

**Company:**

\_\_\_\_\_

**Company stamp:**

**Telephone/fax:**

\_\_\_\_\_

**Contact:**

\_\_\_\_\_

**Signature:**

\_\_\_\_\_

# Questionnaire EB 800

Fax Enquiry / Order  
simply photo-copy, complete and fax...

- Enquiry     
  Order     
  Repeat order, no. of initial order

**Gun drill:**

EB 800 

Quantity required: \_\_\_\_\_ tools

\_\_\_\_\_ interchangeable inserts  
 \_\_\_\_\_ guide pads

\* Ø 12.0 - 40.0 mm

Flute length min. 15 x D

Total length max. 3000 mm

Total length and driver length are dependent  
on the driver selected, see page 48.

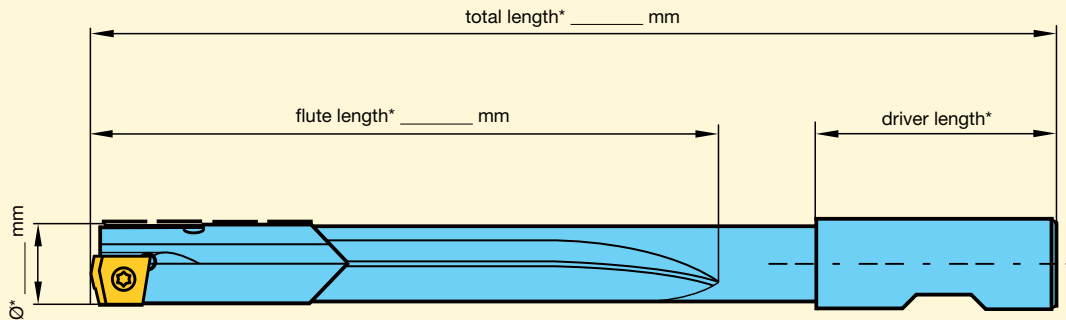



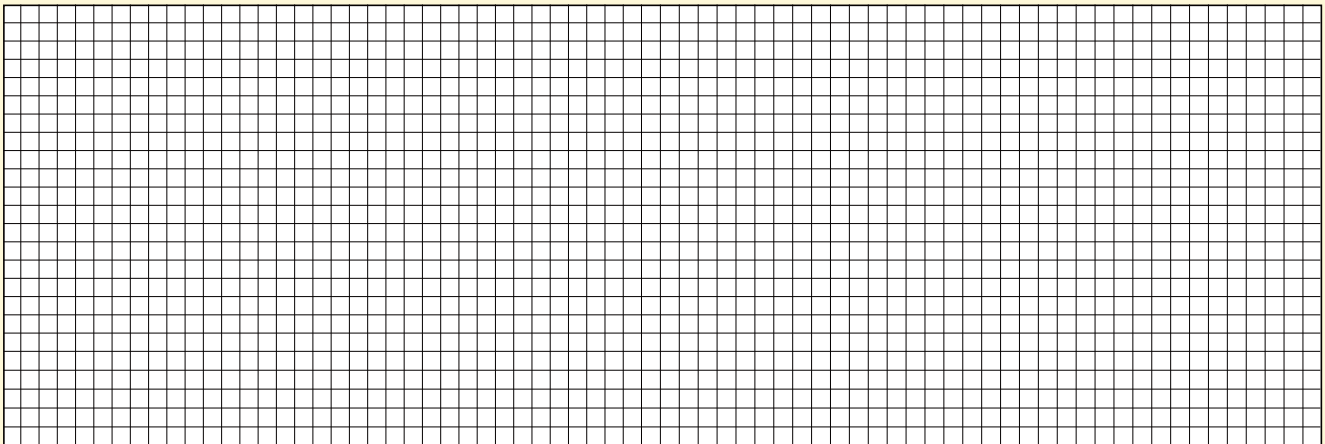



**Drawing of lay-out**



required in special cases only

**Driver:**       no       code no. \_\_\_\_\_       to enclosed drawing

**Coating:**       TiN        Fire        TiCN        TiAlN        TiAlN SuperA        TiAlN nanoA 

**Workpiece:**      **Drilling depth:** \_\_\_\_\_      **Hole tolerance:** \_\_\_\_\_      **Material/designation:** \_\_\_\_\_  
**Surface finish:** \_\_\_\_\_      **Projecting edges :**  no       yes \_\_\_\_\_

**Machine type:**       Deep hole drilling machine       Conventional machine tool  
 Pilot hole       Drilling bush

**Coolant:**       Deep hole drilling oil       Soluble oil  
**Pressure** \_\_\_\_\_ bar      **Quantity** \_\_\_\_\_ l/min

**Company:** \_\_\_\_\_

**Company stamp:** \_\_\_\_\_

**Telephone/fax:** \_\_\_\_\_

**Contact:** \_\_\_\_\_

**Signature:** \_\_\_\_\_

**Please note:**

- All gun drills must be applied with internal cooling, either air, water or oil. Without internal cooling the chips cannot be evacuated.
- All gun drills can be applied with oil as the medium for internal cooling. However, in this case a 30% higher pressure is required in order to achieve the same coolant volume.
- When MQL is applied with gun drills an increase in pressure may be necessary for smaller nominal diameters dependent on the pressure of the MQL system.
- If the cooling lubricant data is insufficient the cutting parameters may be reduced. Pressure boosting systems are also possible.

**Coolant values EB 100**

(recommended values for soluble oil)

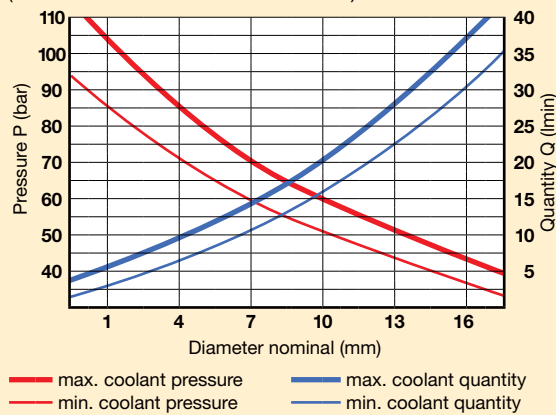

**Coolant values EB 80**

(recommended values for soluble oil)

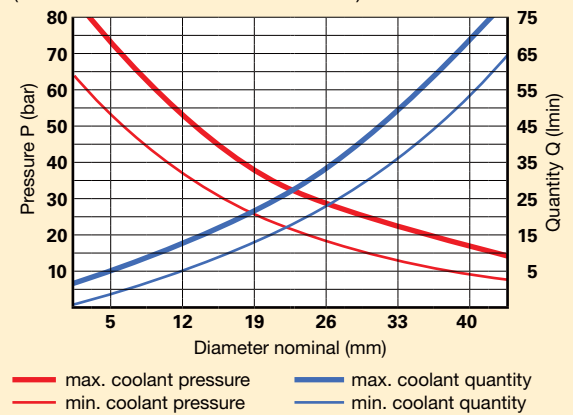

**Coolant values ZB 80**

(recommended values for soluble oil)

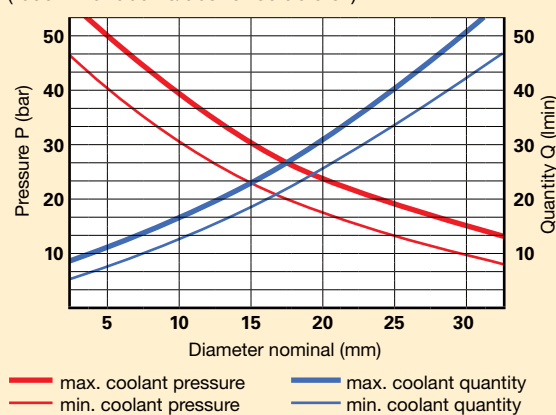

**Coolant values EB 800**

(recommended values for soluble oil)

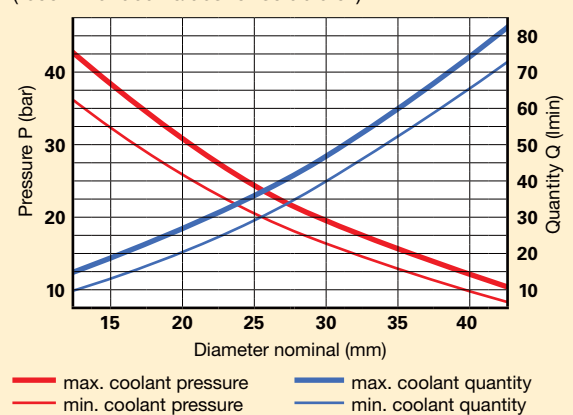



**GUHRING**

# GUHRING NAVIGATOR

GUHRING  
NAVIGATOR



**Application advice**

- For drilling depths in excess than 40 x D we recommend the use of two or more gun drills, e. g. Ø 10 x 400 mm and Ø 9.95 x 800 mm.
- Gun drills for drilling depths of more than 40 x D should enter the pilot hole revolving in the left hand direction.
- When changing tools for drilling depths of more than 40 x D, the tool can be damped by switching on coolant supply for just one second.
- For machining of long-chipping materials we recommend the use of gun drills with polished flutes.
- Generally we recommend the use of soluble oil with a minimum oil content of 10 %.
- Single-fluted gun drills for long-chipping aluminium should be supplied with point grind 180° and coolant chamber.
- When spotting in aluminium with an Si-content of less than 1%, i.e. with recommended cutting rates  $v_c > 160$  m/min we recommend to advance to the final speed in several steps. In addition, a deeper pilot hole of approximately 3 x D should be produced.

**EB80**

single-fluted gun drill  
solid carbide head

2.0 ... 40.0



**ZB80**

two-fluted gun drill  
solid carbide head

6.0 ... 27.0



**EB800**

single-fluted gun drill  
with indexable inserts

12.0 ... 40.0



rec. coating*	≤35xD		>35xD		rec. coating*	≤35xD		>35xD		rec. coating*	≤35xD		>35xD	
	$v_c$ m/min	Feed col. no.	$v_c$ m/min	Feed col. no.		$v_c$ m/min	Feed col. no.	$v_c$ m/min	Feed col. no.		$v_c$ m/min	Feed col. no.	$v_c$ m/min	Feed col. no.
S	100	14	95	13						S	90	15	85	15
	85	14	80	13							S	80	15	75
S	90	14	85	13						S	85	16	80	16
	80	14	75	13							S	75	16	70
S	90	13	85	12						S	85	15	80	15
	80	13	75	12							S	80	15	75
S	75	13	70	12						S	75	15	70	15
	75	13	70	12							S	75	15	70
S	65	13	60	12						S	65	15	60	15
	80	14	75	13							S	80	15	75
S	75	13	70	12						S	75	15	70	15
	65	13	60	12							S	65	15	60
C	75	13	70	12						S	70	15	65	15
	65	13	60	12							S	60	15	55
C	75	12	70	11						S	65	14	60	14
	65	12	60	11							S	60	14	55
C	55	11	50	11						S	55	14	50	14
	65	12	60	12							S	65	15	60
C	55	13	50	12						S	50	14	45	14
	45	13	40	12							F	45	14	40
C	35	13	35	12						S	40	14	35	14
	30	12	25	11							F	30	13	25
C	25	11	20	11						S	25	12	20	12
	20	11	20	11							F	25	13	20
	85	15	80	14		85	18	80	17		85	16	80	16
	80	15	75	14			80	18	75		17		80	16
	80	14	75	13		75	17	70	16		80	16	75	16
	70	14	65	13			70	17	65		16		75	16
	55	13	50	12		65	16	60	15		70	16	65	16
	35	11	30	11								55	15	50
C	30	11	25	11						F	35	13	30	13
	150	16	140	15								30	12	25
	120	15	115	14		120	18	115	17		140	16	135	16
	150	16	140	15			110	18	105		17		125	16
	130	16	120	15		135	18	130	17		170	17	165	17
	110	16	100	15			120	17	115		16		140	17
C	75	14	70	13						F	115	16	110	16
	120	17	115	16								75	15	70
	90	17	85	16		130	18	125	17		120	17	115	17
	95	16	90	15			120	18	115		17		90	17
	75	16	70	15		110	17	105	16		95	17	90	17
	70	16	65	15			110	17	105		16		75	17
	60	16	55	15		95	17	90	16		70	17	65	17
	75	14	70	13			95	17	90		16		60	17
	70	14	65	13							75	16	70	16
												70	16	65
	60	13	55	12										
	50	13	45	12								60	15	55
										50	15	45	15	

GUHRING KG | Telephone: +49 74 31 17 - 0 | Fax: +49 74 31 17 - 21 279  
Herderstrasse 50 - 54 | 72458 Albstadt | Germany | [info@guehring.de](mailto:info@guehring.de) | [www.guehring.de](http://www.guehring.de)

No liability can be accepted for printing errors or technical changes of any kind.  
Our Conditions of Sale and Terms of Payment apply. Available on request.